

# PHEASANT<sup>®</sup> SURGICAL

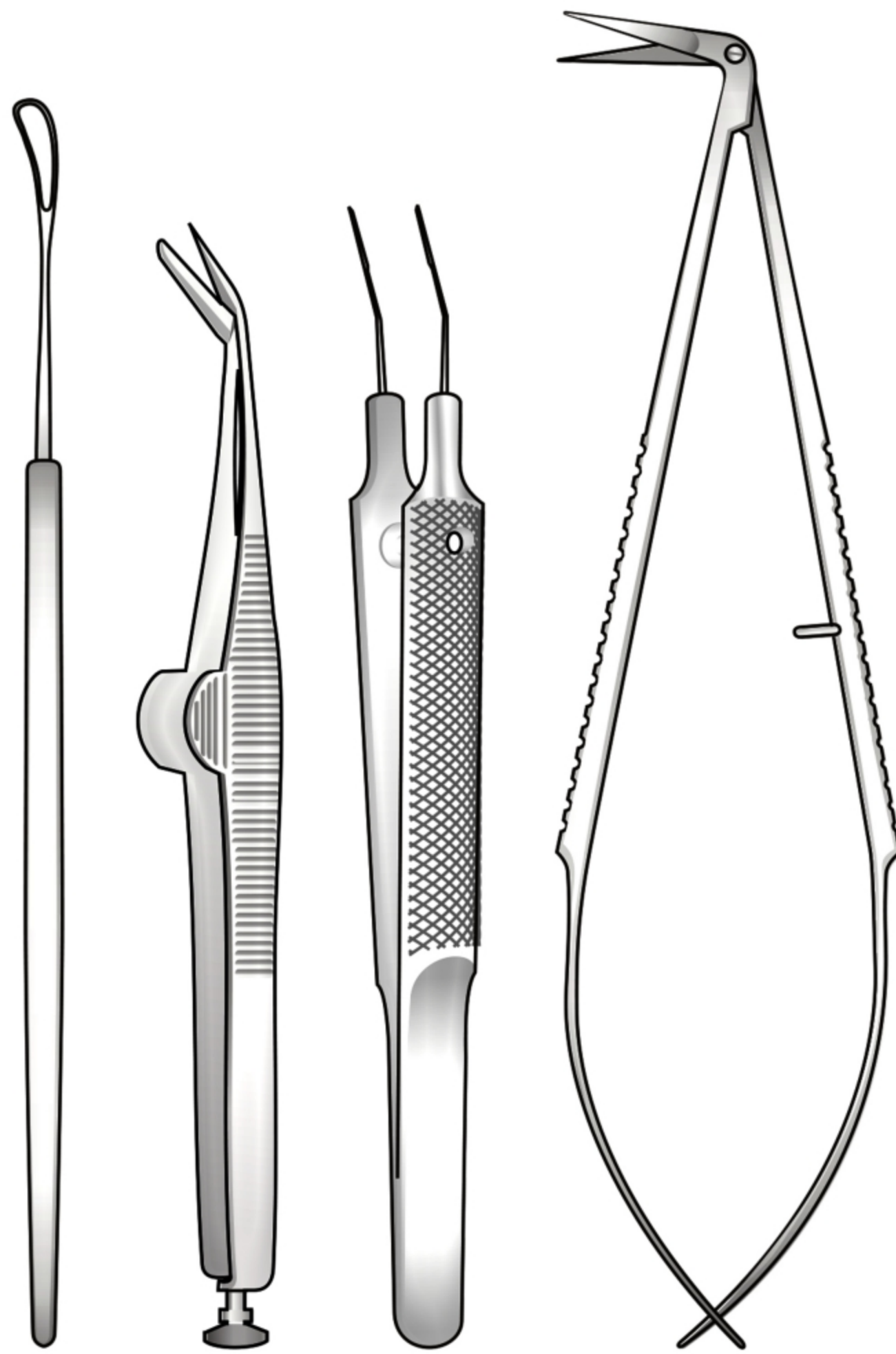

## Ophthalmology

Ophthalmologie

Ophthalmologie

Oftalmología

Oftalmologia



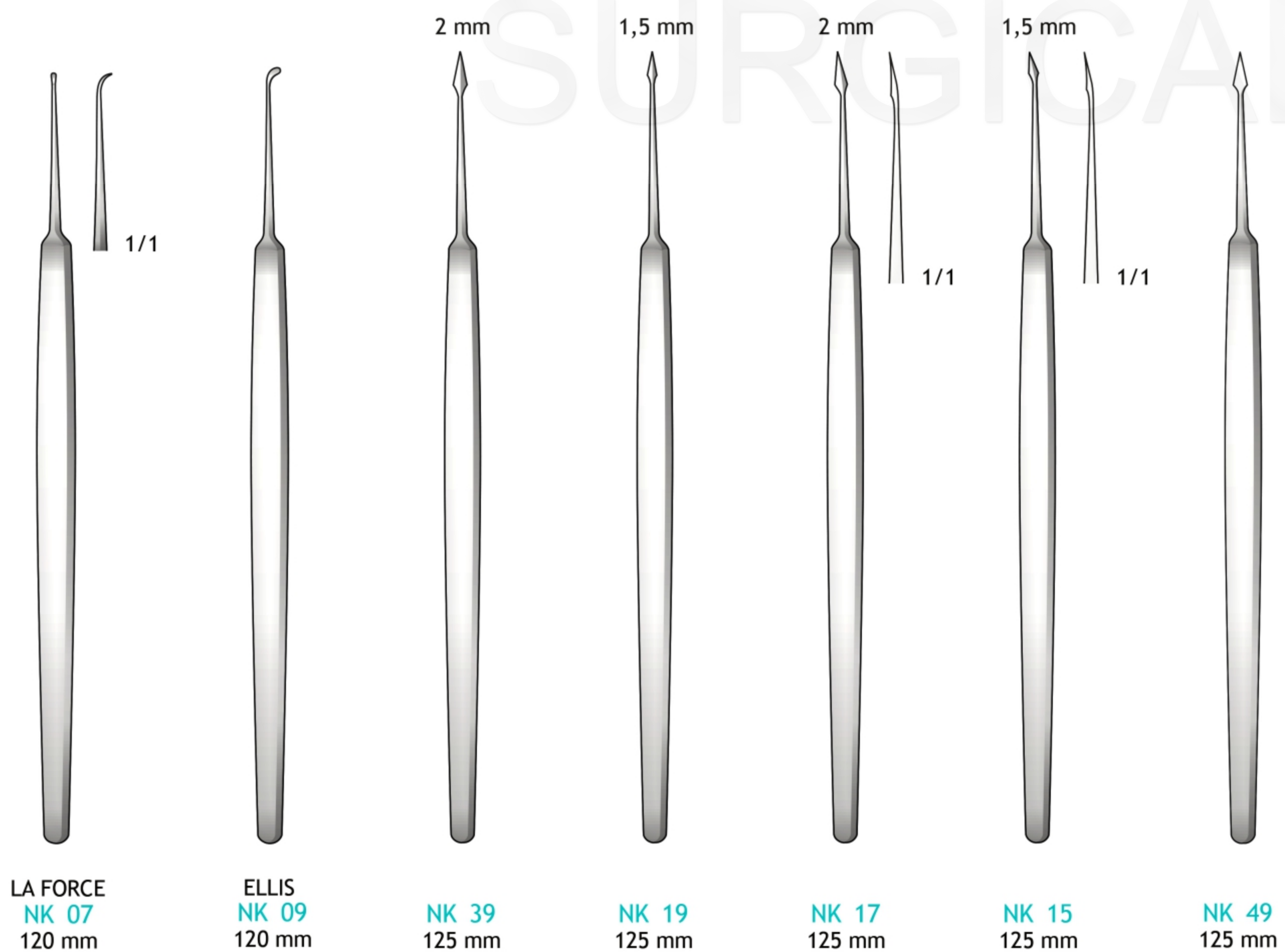
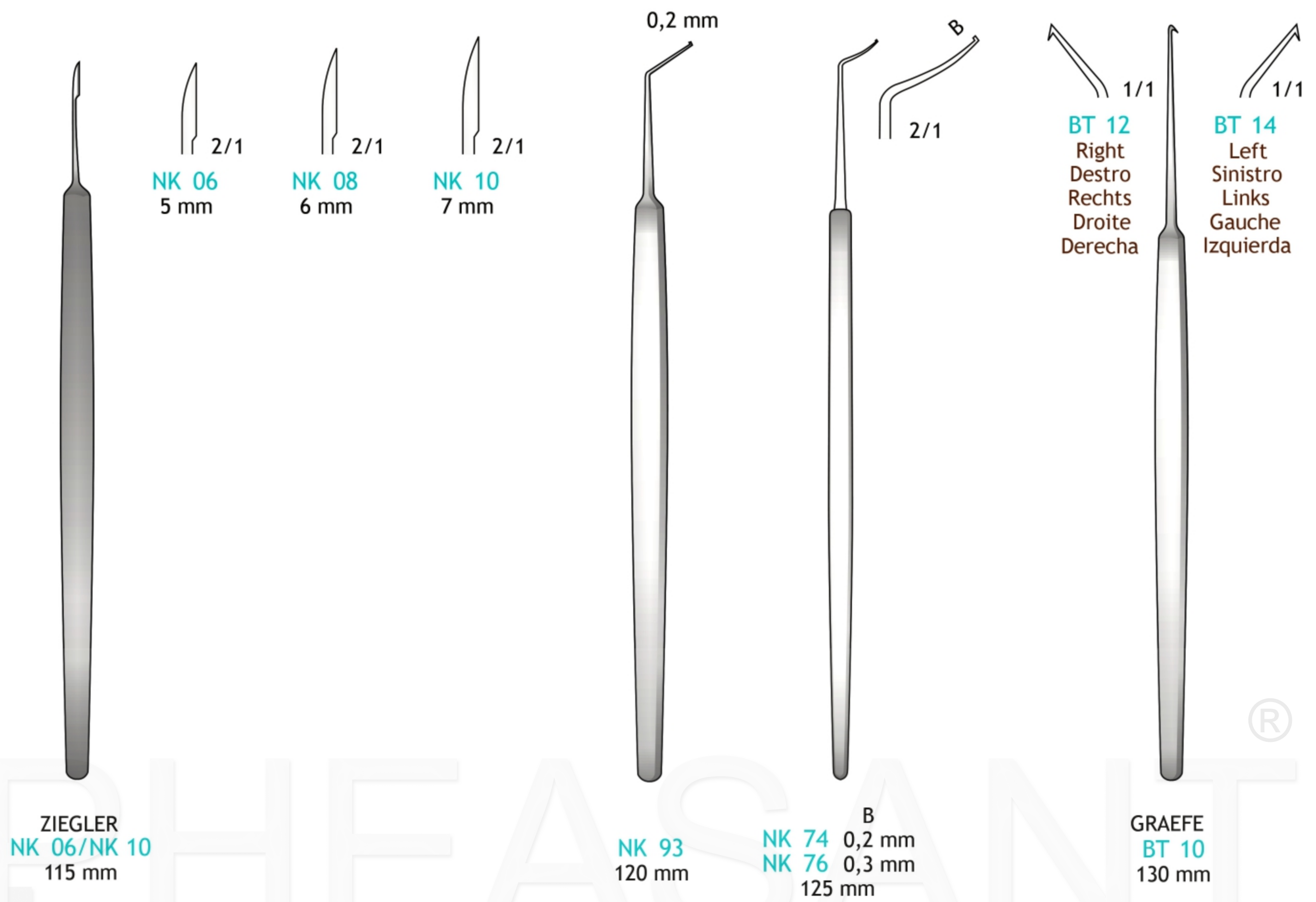



NK 11  
125 mm



NK 13  
120 mm



GRAEFE  
NK 18/NK 20  
140 mm

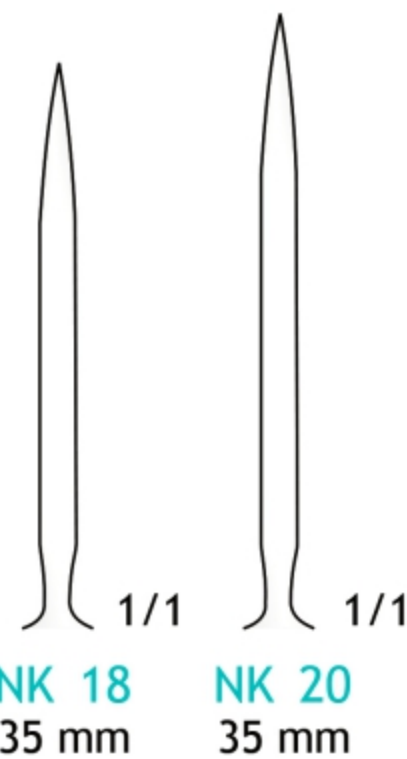

NK 18  
35 mm      NK 20  
35 mm



GRAEFE  
NK 14/NK 16

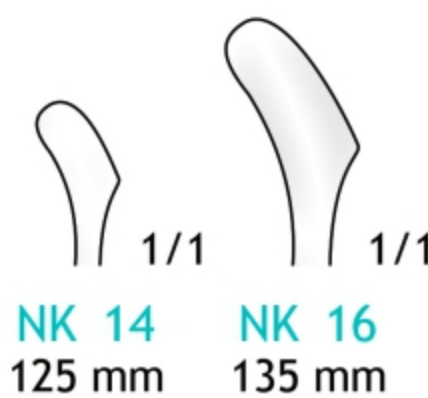

NK 14  
125 mm      NK 16  
135 mm



1/1

WECKER  
NK 27/NK 29  
130 mm

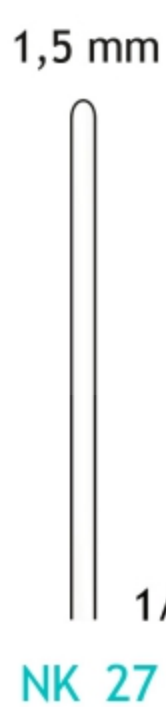

NK 27

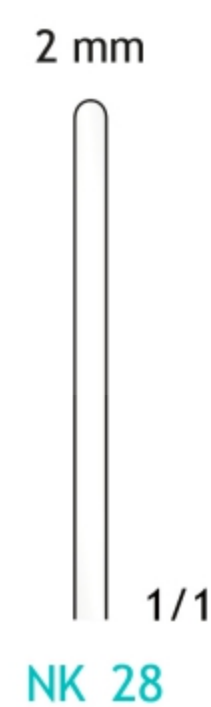

NK 28

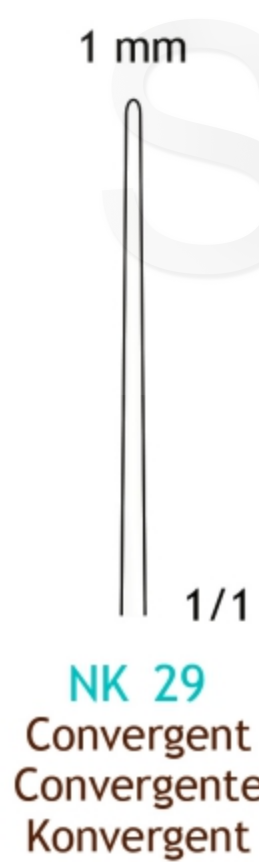

NK 29  
Convergent  
Convergente  
Konvergent



GRAEFE  
NK 41/NK 43  
130 mm



NK 41



NK 42



NK 43

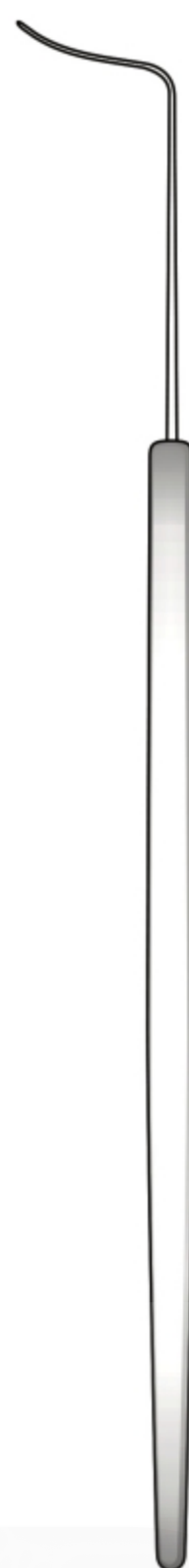

CASTROVIEJO  
NK 21/NK 26



NK 21  
130 mm

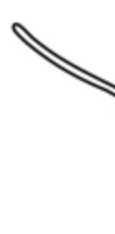

NK 22  
130 mm



NK 23  
130 mm



NK 24  
130 mm



NK 25  
130 mm



NK 26  
130 mm



1/1



SNELLEN  
NK 45  
135 mm



1/1



2/1

NK 03  
Left  
Sinistro  
Links  
Gauche  
Izquierda



NK 03/NK 04  
140 mm



2/1

NK 04  
Right  
Destro  
Rechts  
Droite  
Derecha



NK 44  
130 mm

4 mm



1/1



NK 75  
130 mm



WEBER  
NK 46/NK 47  
135 mm



1/1



1/1

NK 46



1/1

NK 47

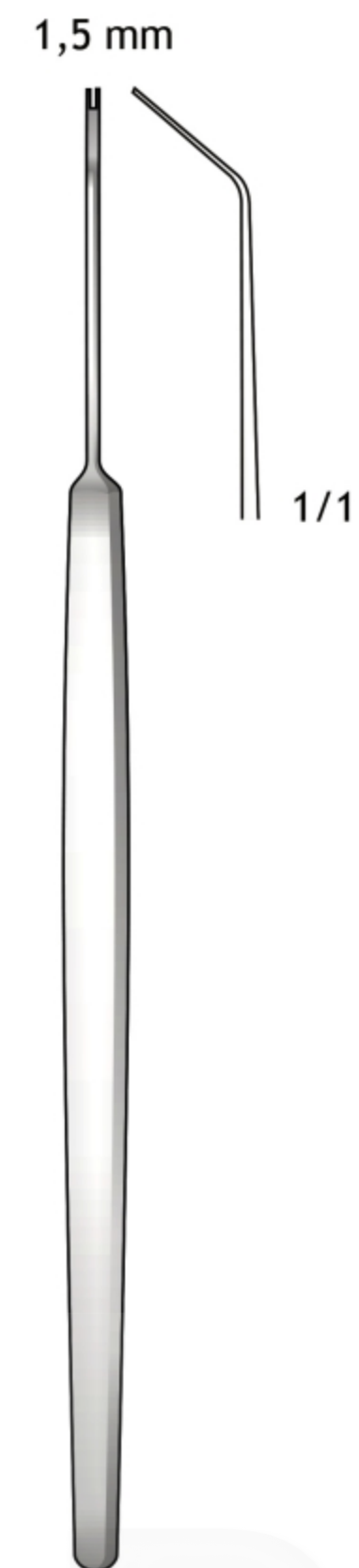

NK 109  
130 mm

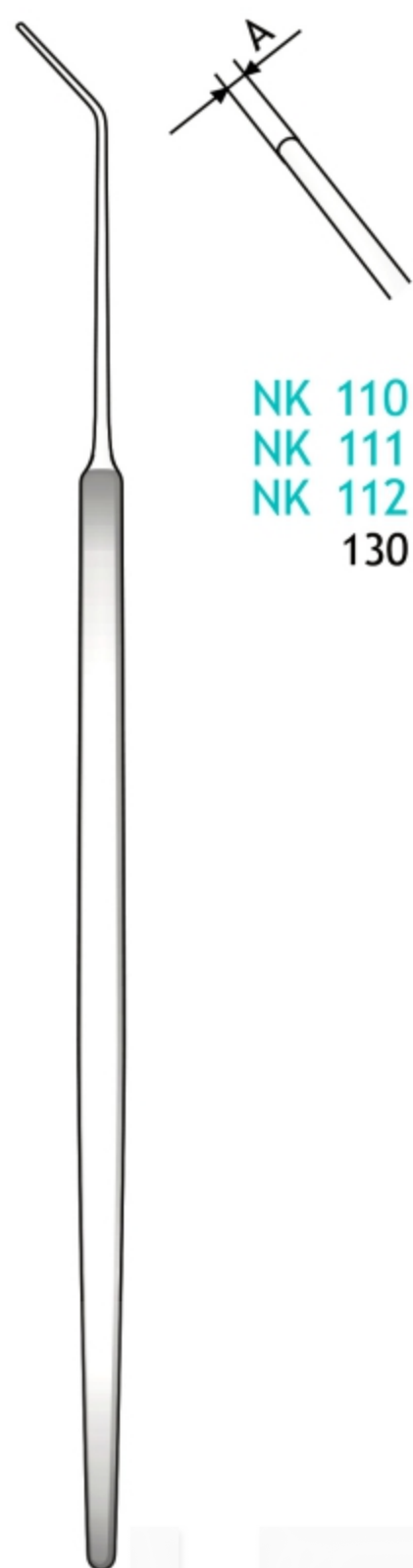

CASTROVIEJO  
NK 110/NK 112  
130 mm

A  
NK 110 0,6 mm  
NK 111 1,0 mm  
NK 112 1,5 mm  
130 mm



NK 05  
140 mm



NK 94  
165 mm



KIMURA  
NK 48  
150 mm

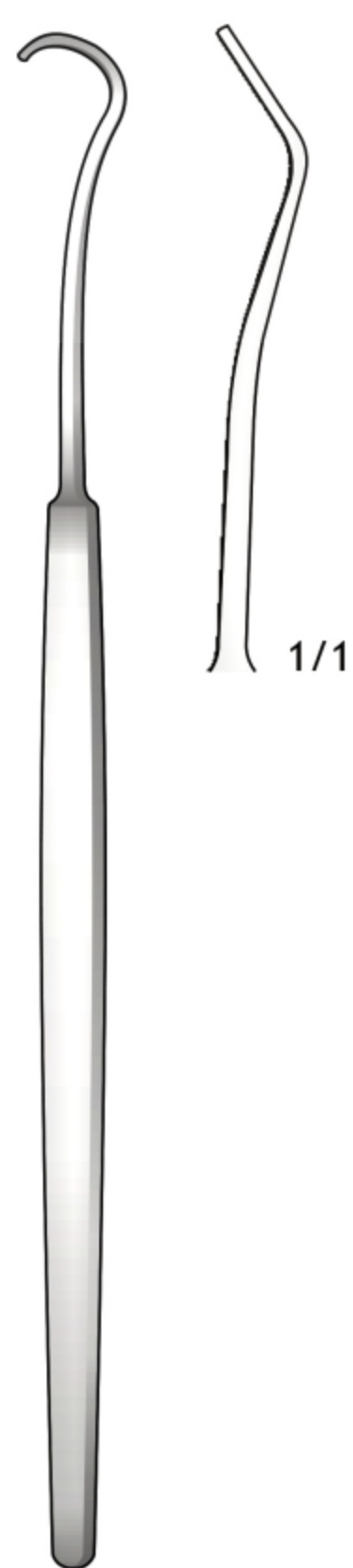

ARRUGA  
NK 59  
140 mm



NK 107  
130 mm

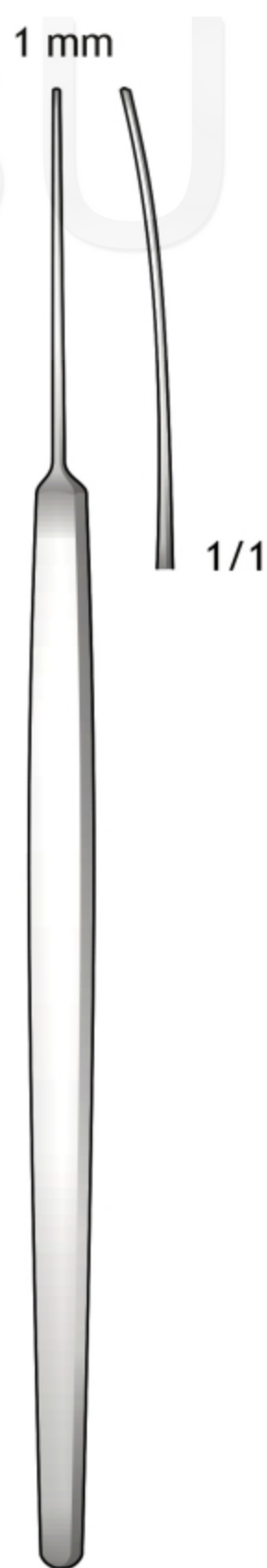

NK 108  
130 mm

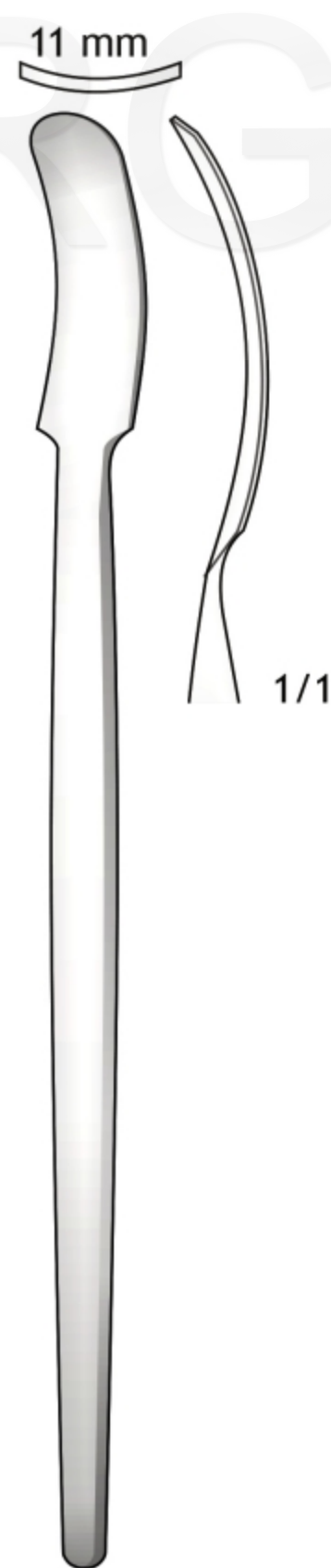

NK 105  
125 mm

Lacrymal dilators  
Tränenkanal Dilatadoren  
Dilatatori lacrimali  
Dilatadores lacrimales

Fig.1

Fig.2

Fig.3



WILDER  
NK 97  
100 mm



WILDER  
NK 98  
100 mm



WILDER  
NK 99  
100 mm

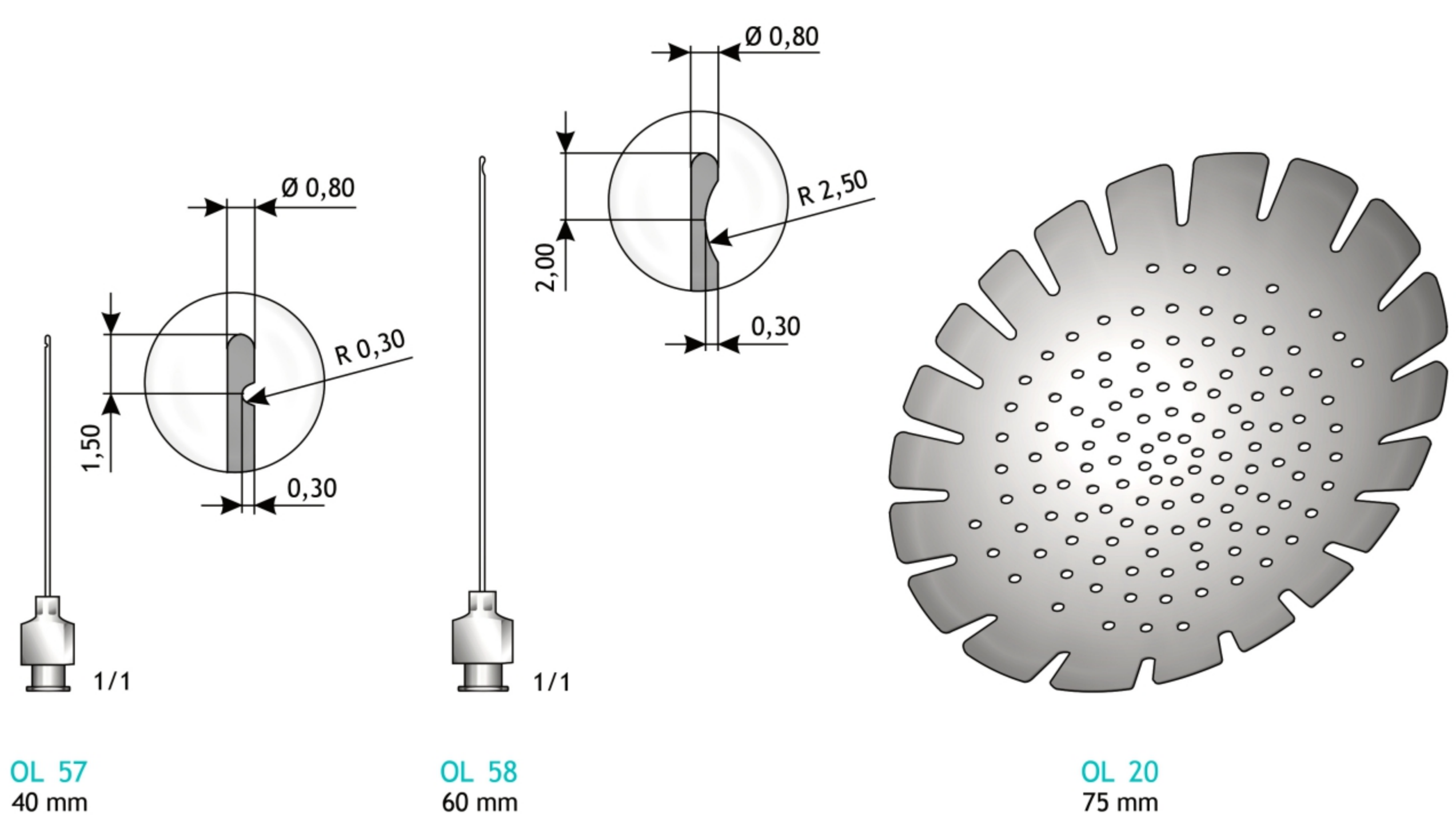
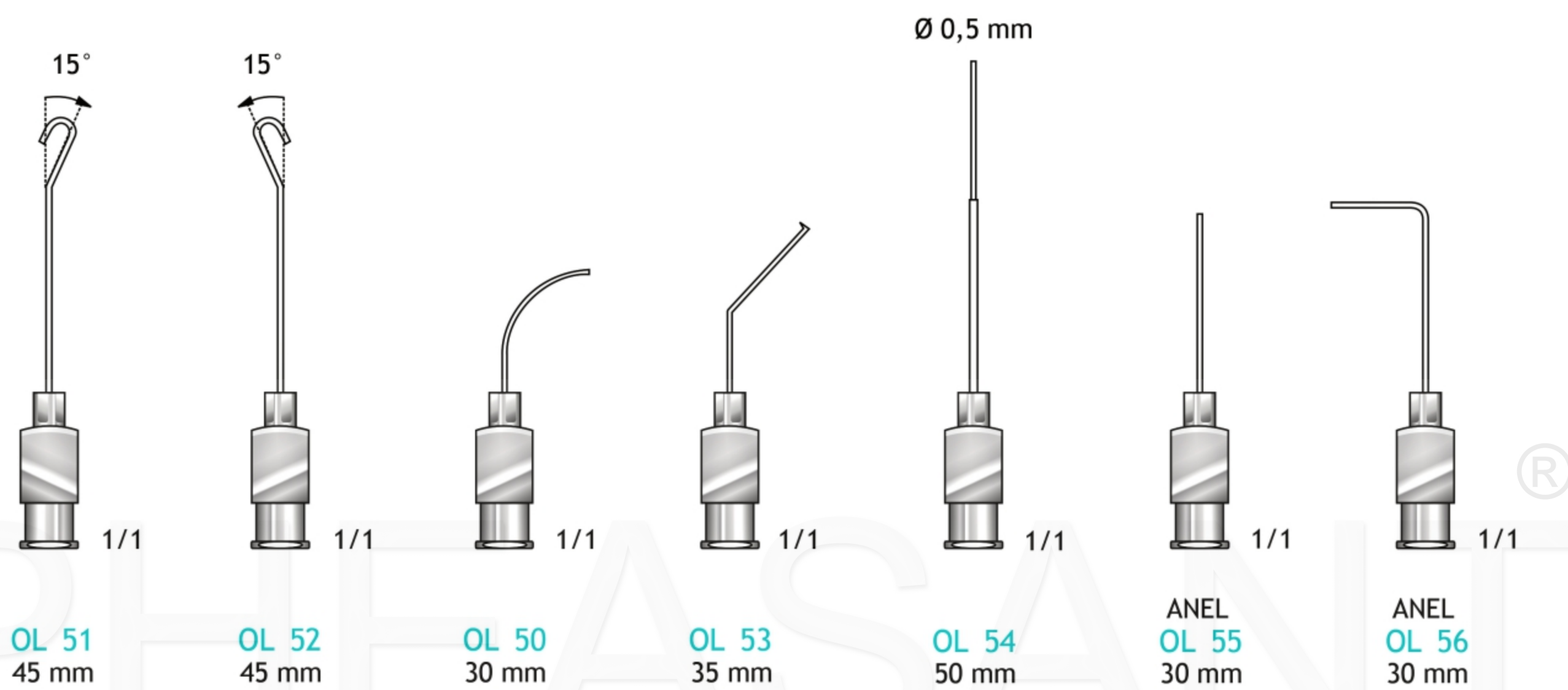

Micro Forceps - Micro Pinzette - Mikro Pinzetten - Micro pinces - Pinzas finos

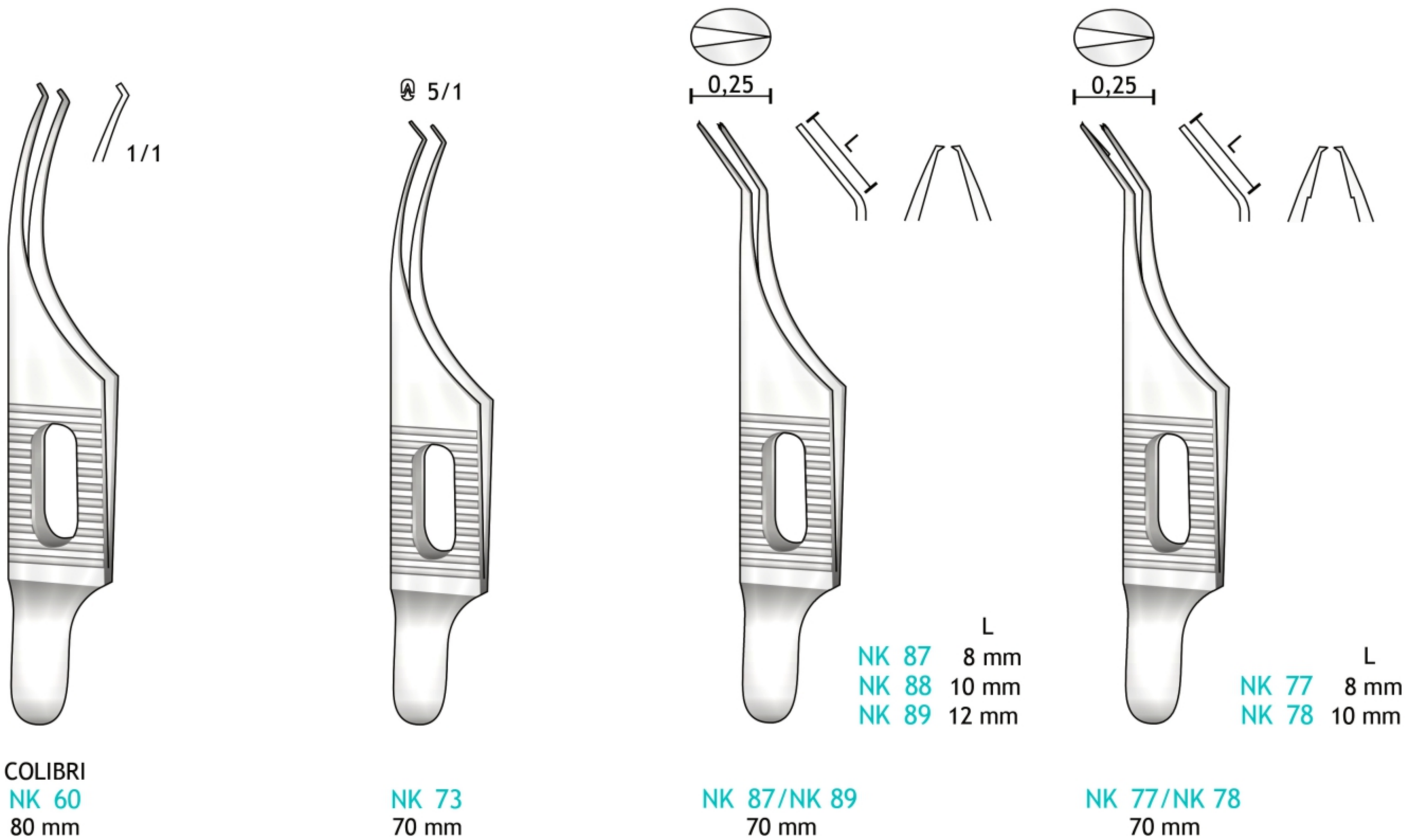
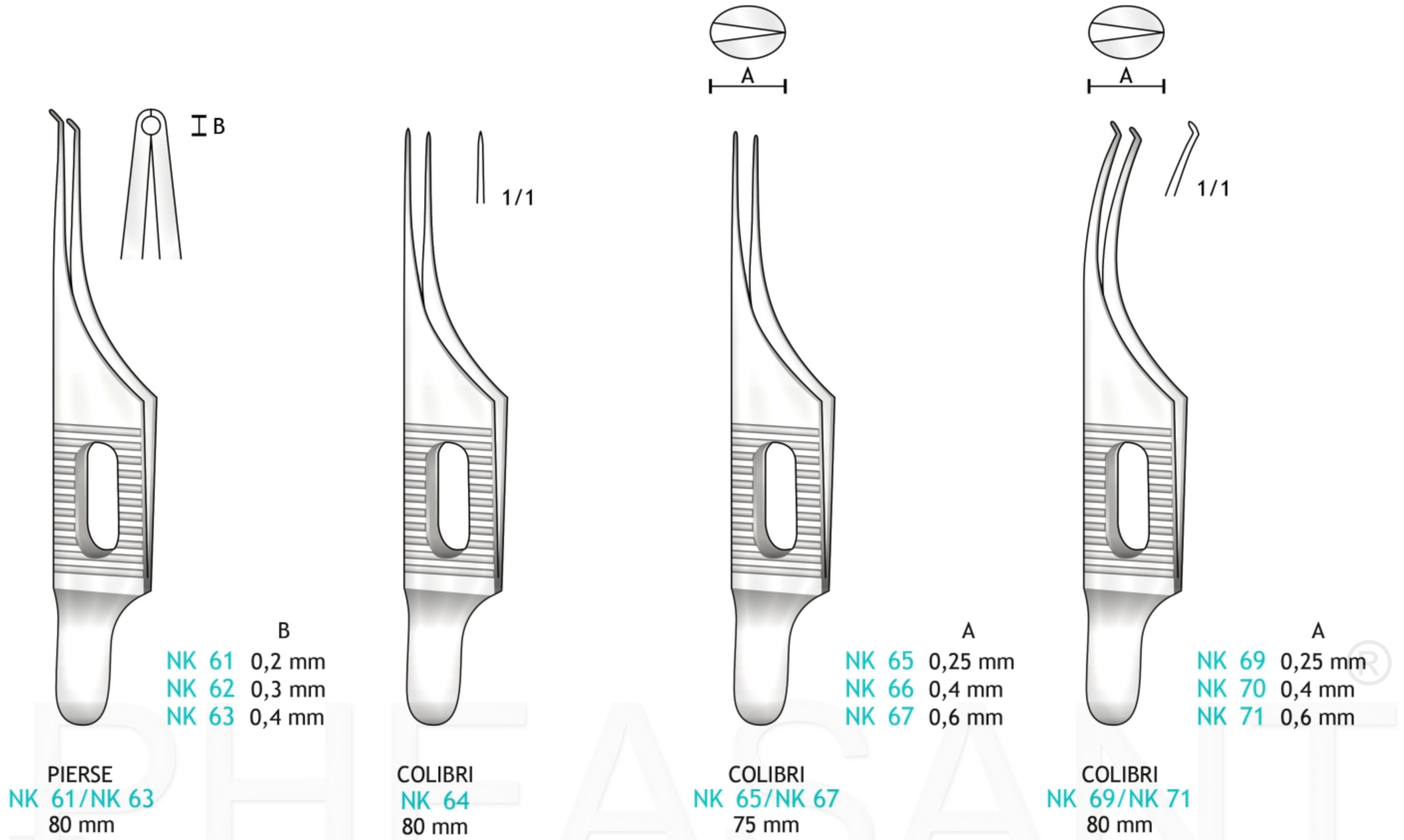



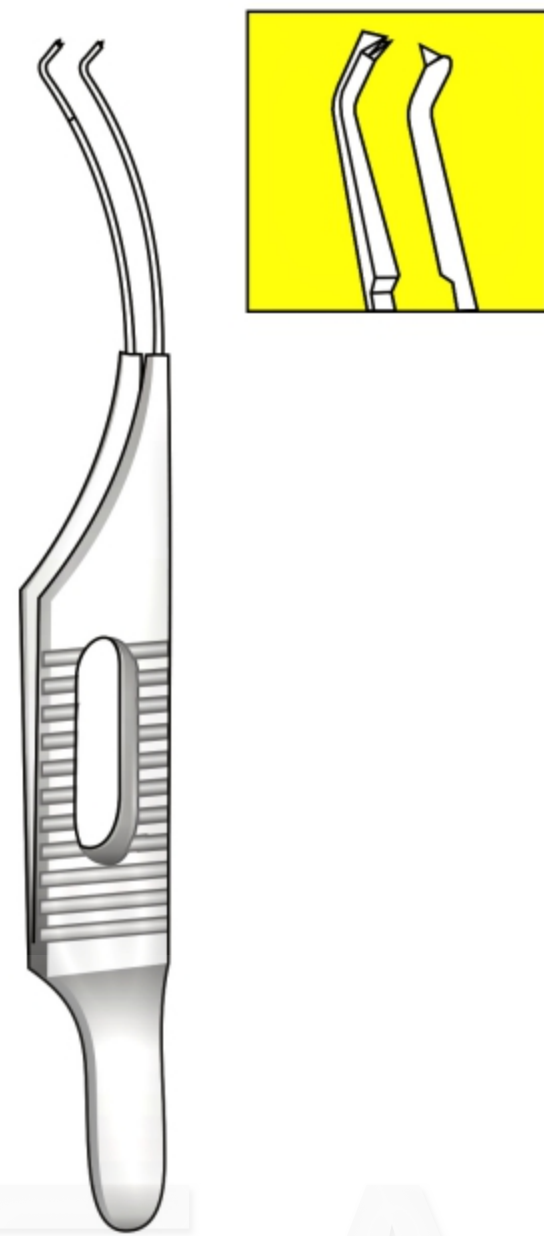

BARRAQUER  
NK 403

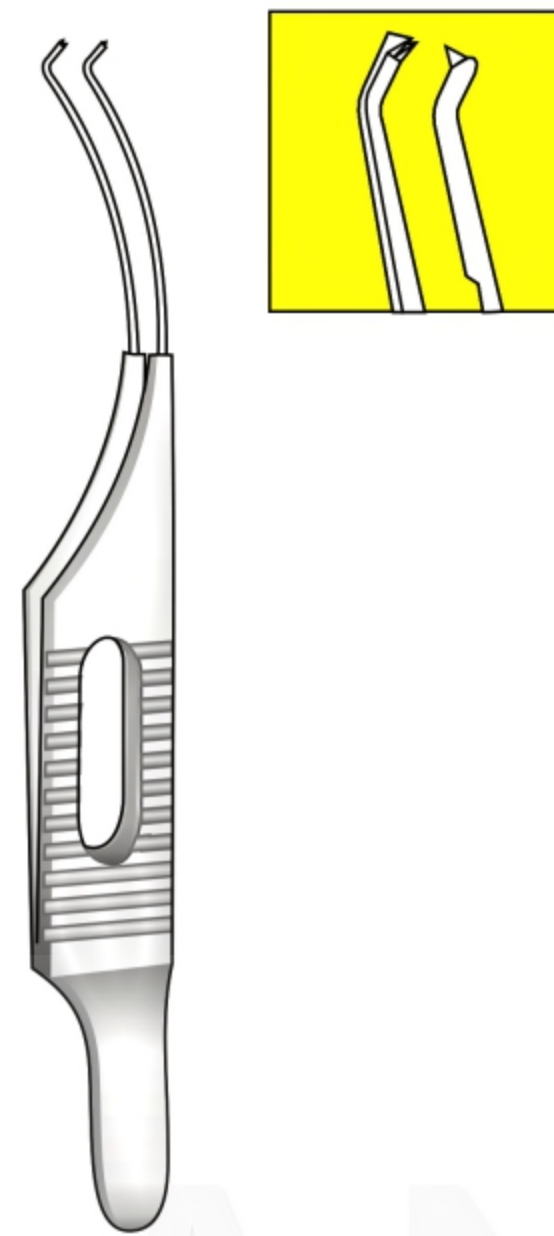

BARRAQUER  
NK 401

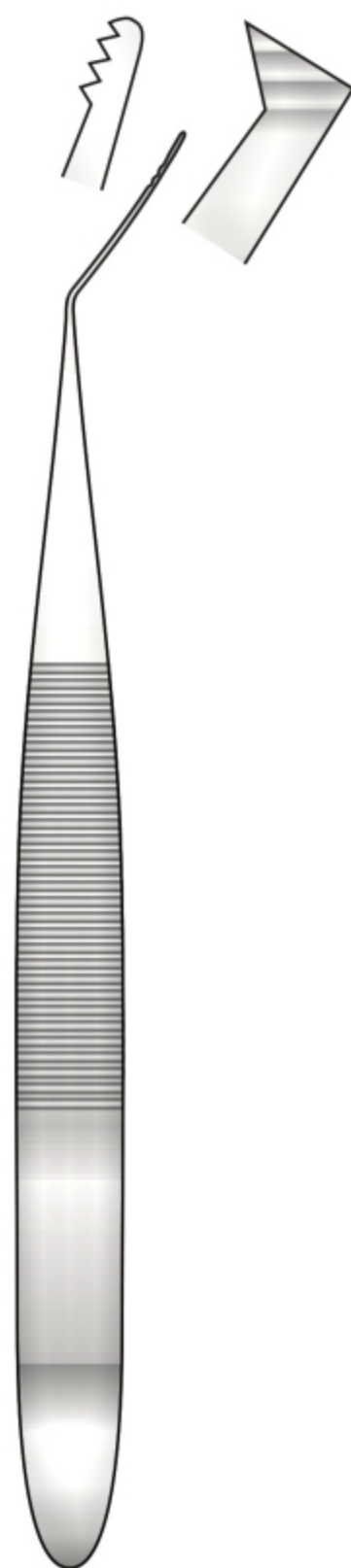

FD 118  
95 mm

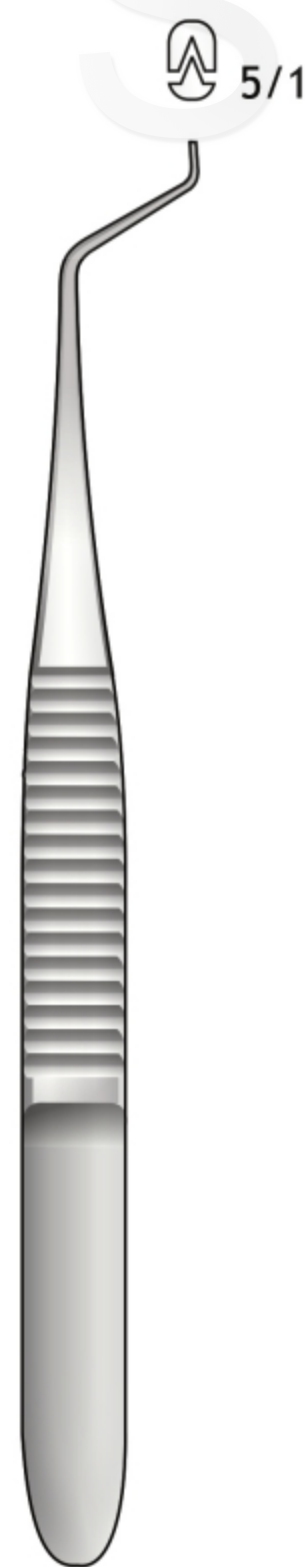

FD 119  
90 mm

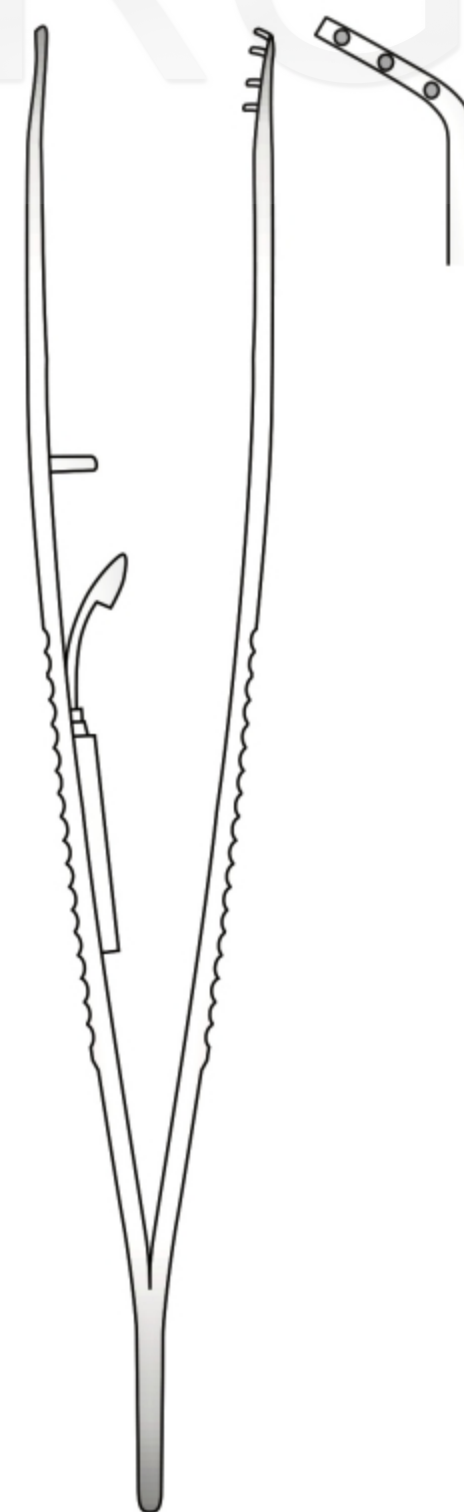

FD 120  
95 mm

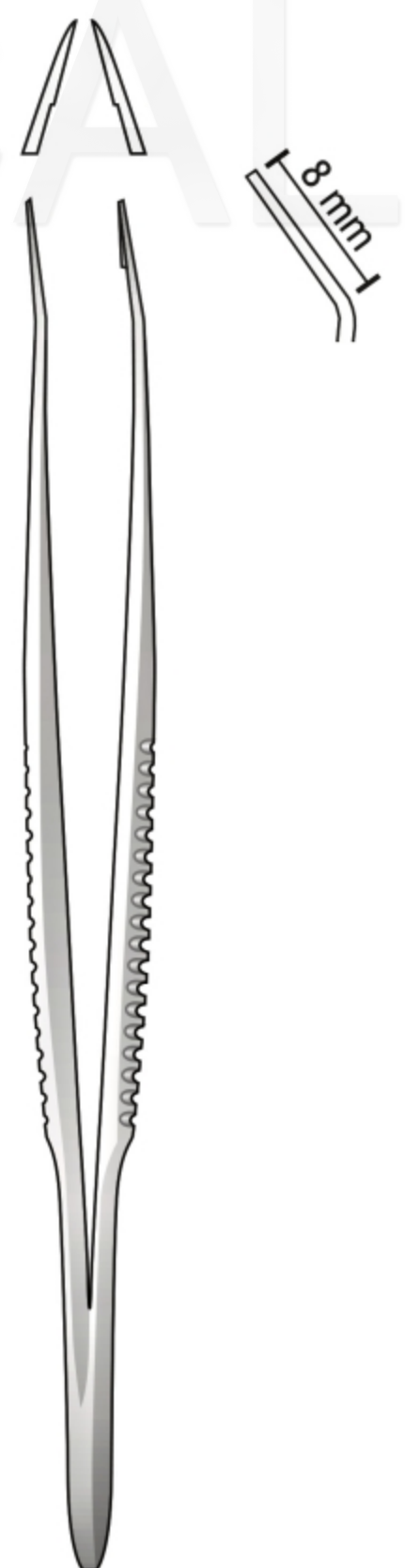

Mc PHERSON  
FD 123  
95 mm

PHEASANT<sup>®</sup>  
SURGICAL

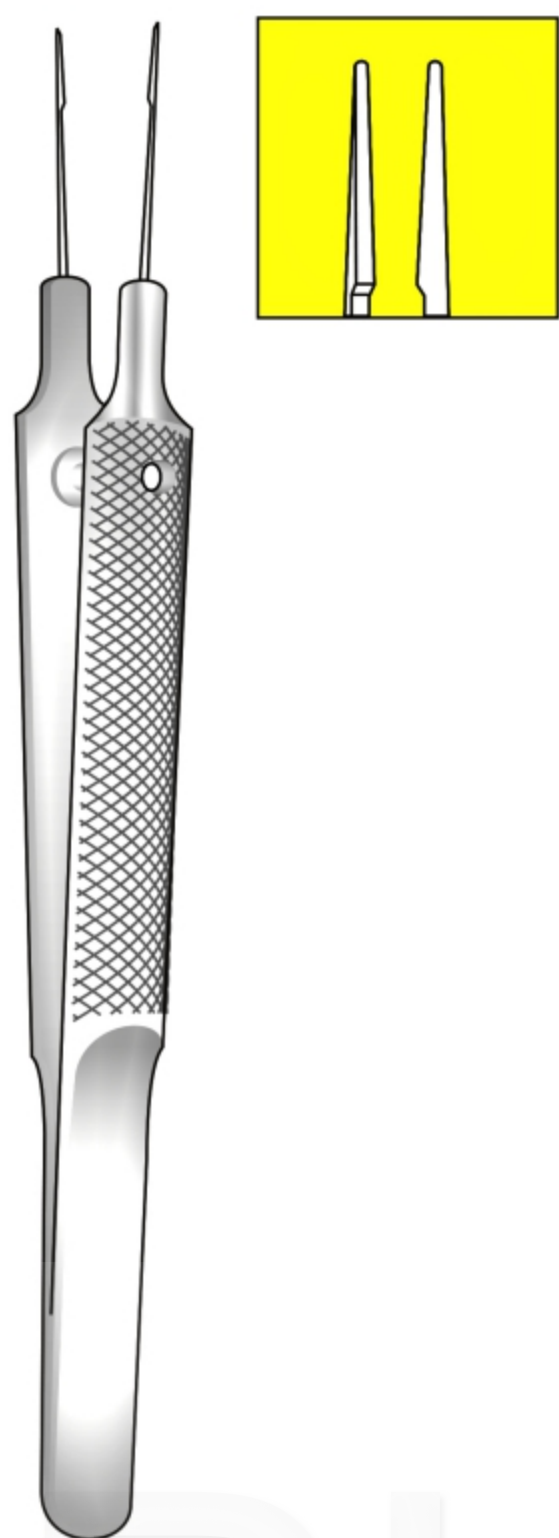

MF 150

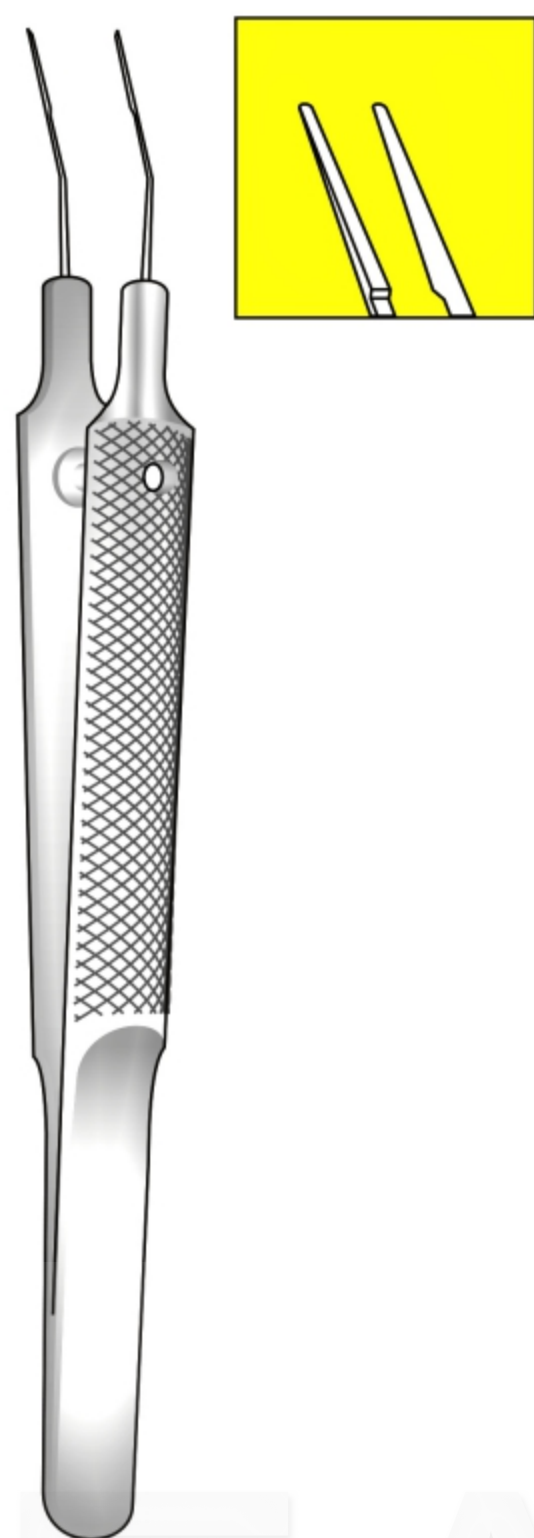

MF 151



CASTROVIEJO  
MF 245

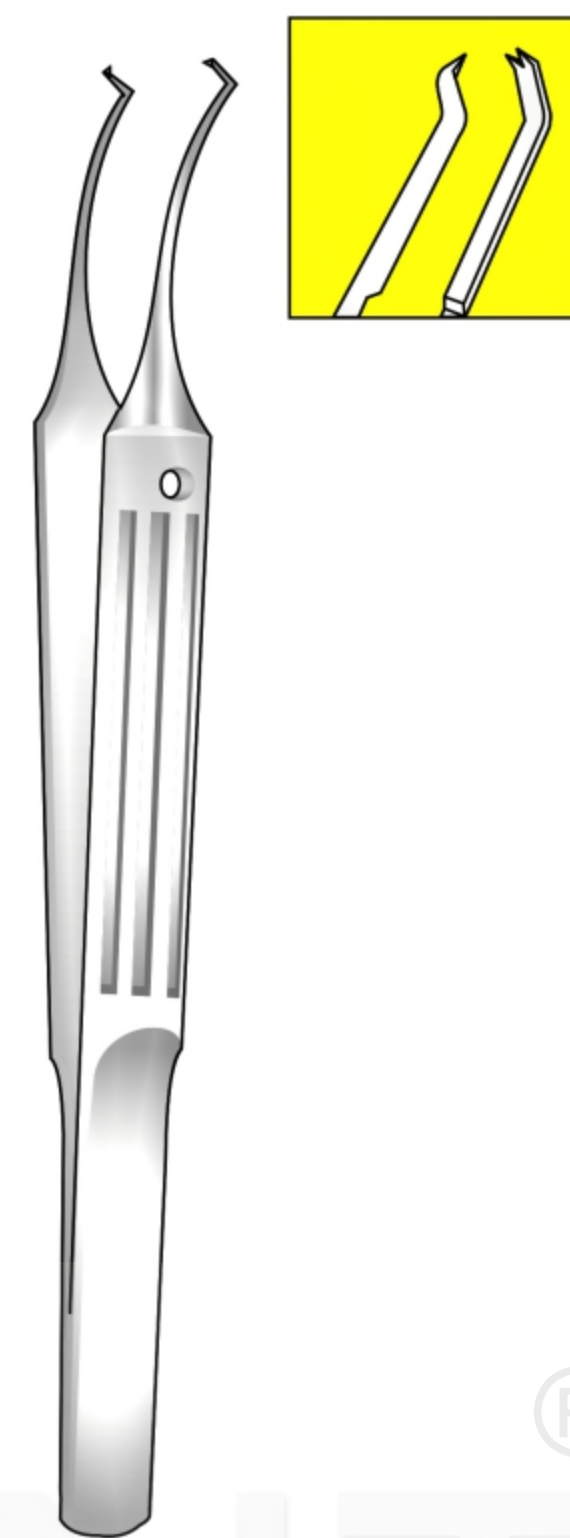

TROUTMAN  
MF 246

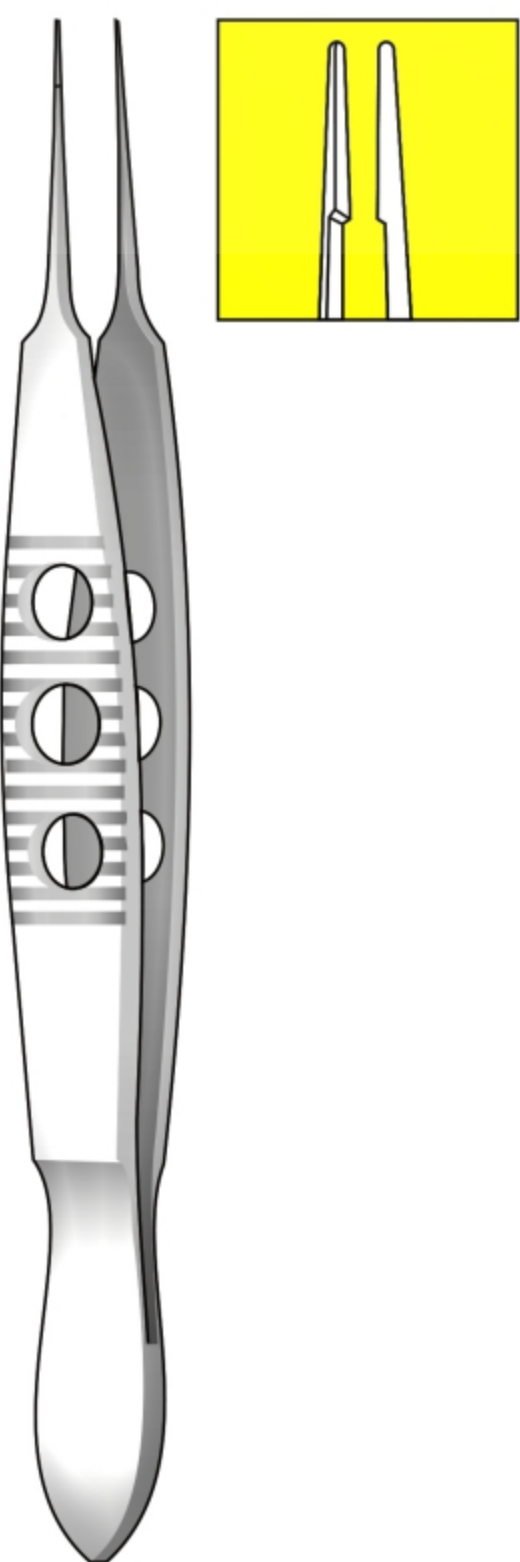

MC PHERSON  
MF 231

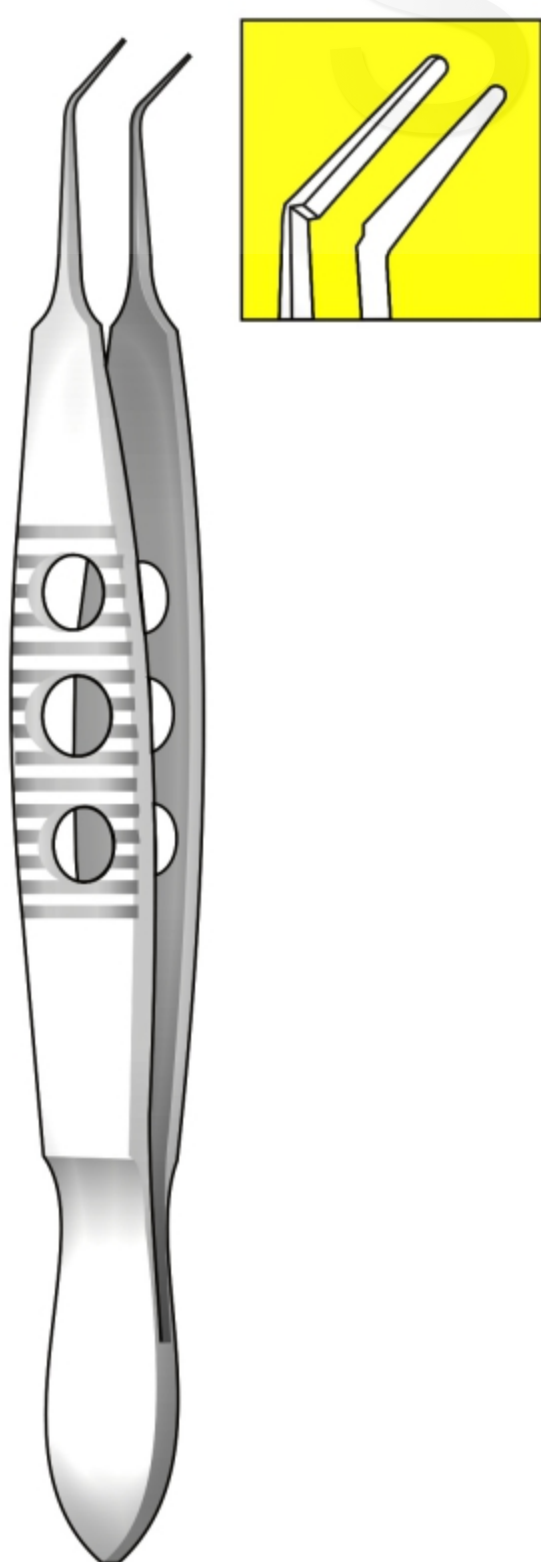

MC PHERSON  
MF 232

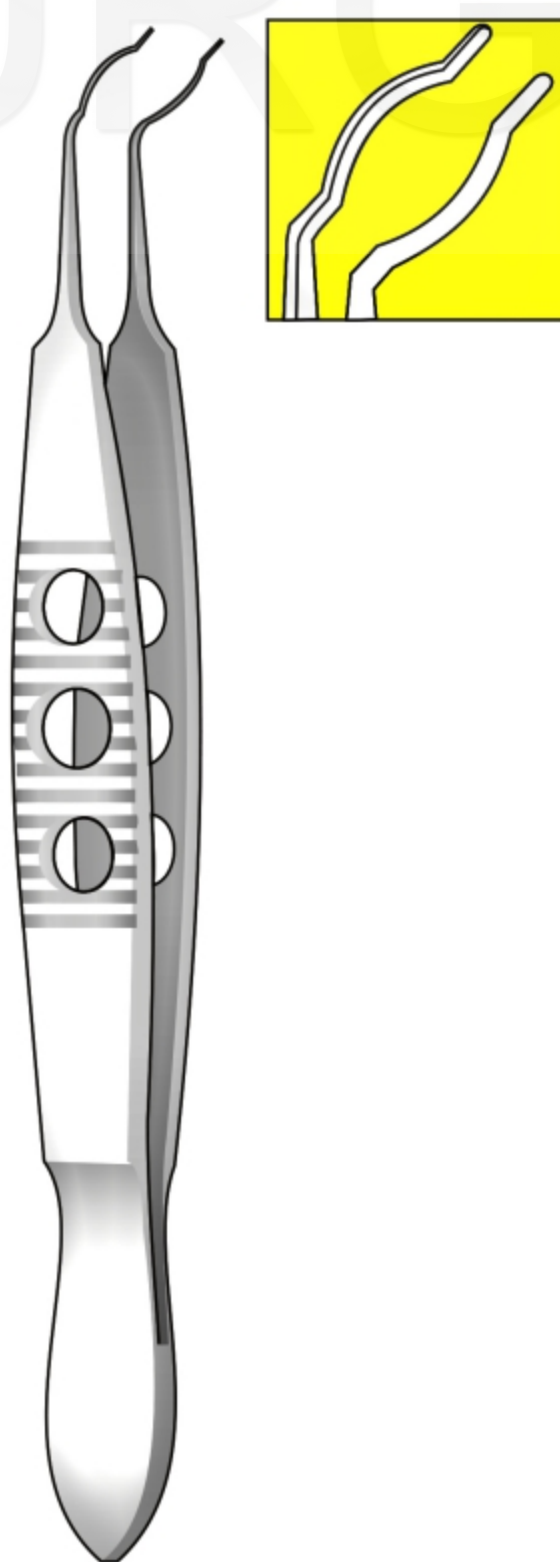

OSHIKA-FAULKNER  
MF 279

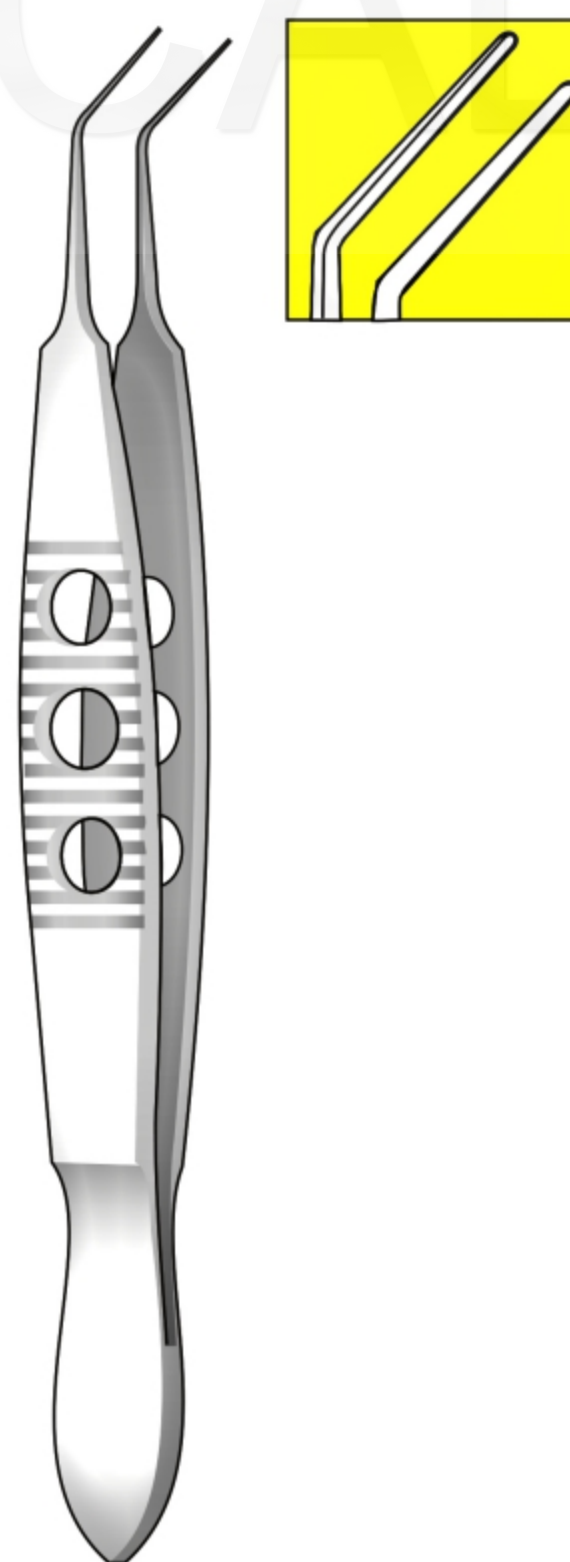

FAULKNER  
MF 278

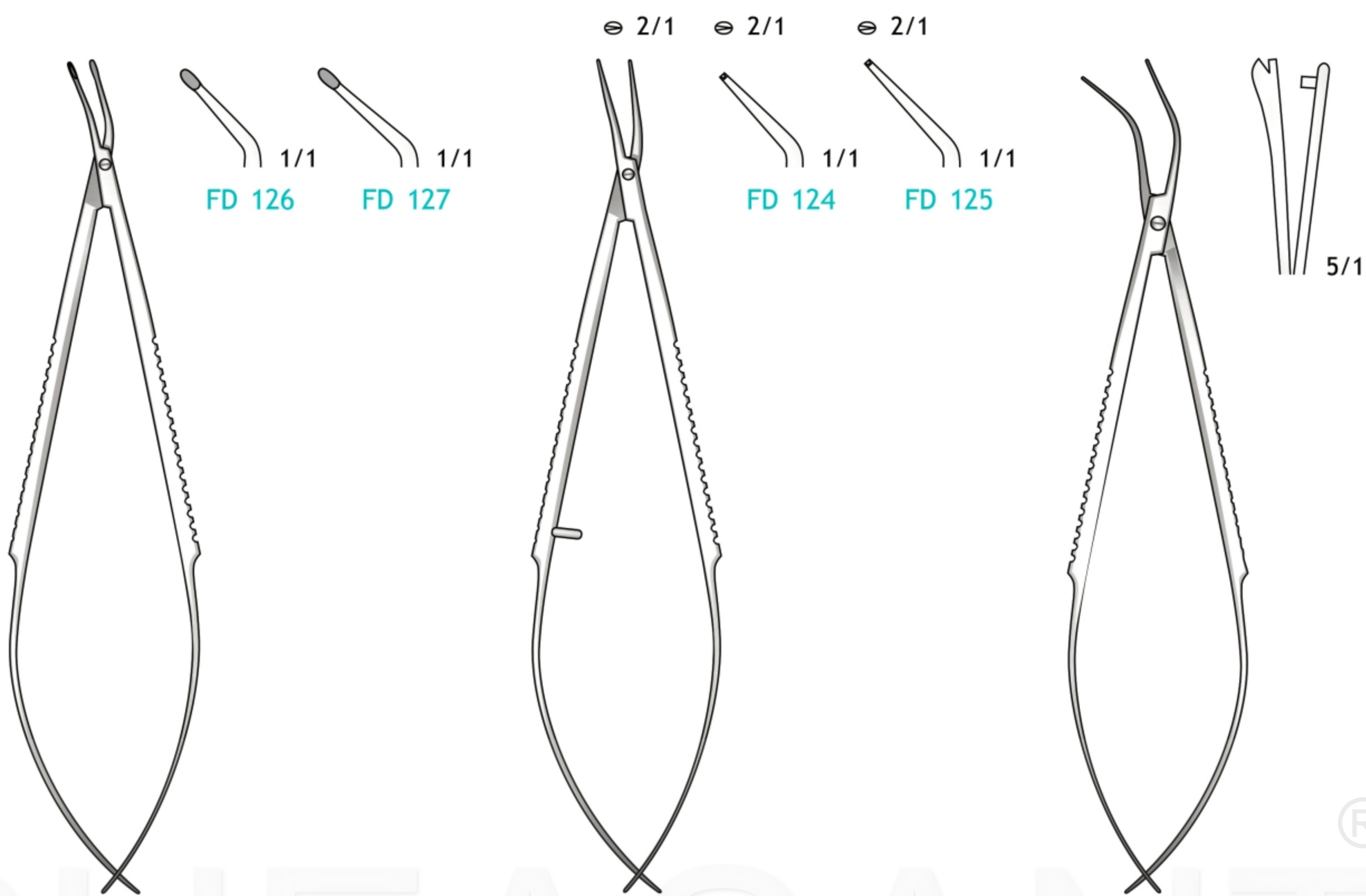

**FD 126/FD 127**  
110 mm

**FD 124/FD 125**  
110 mm

**FD 130**  
110 mm

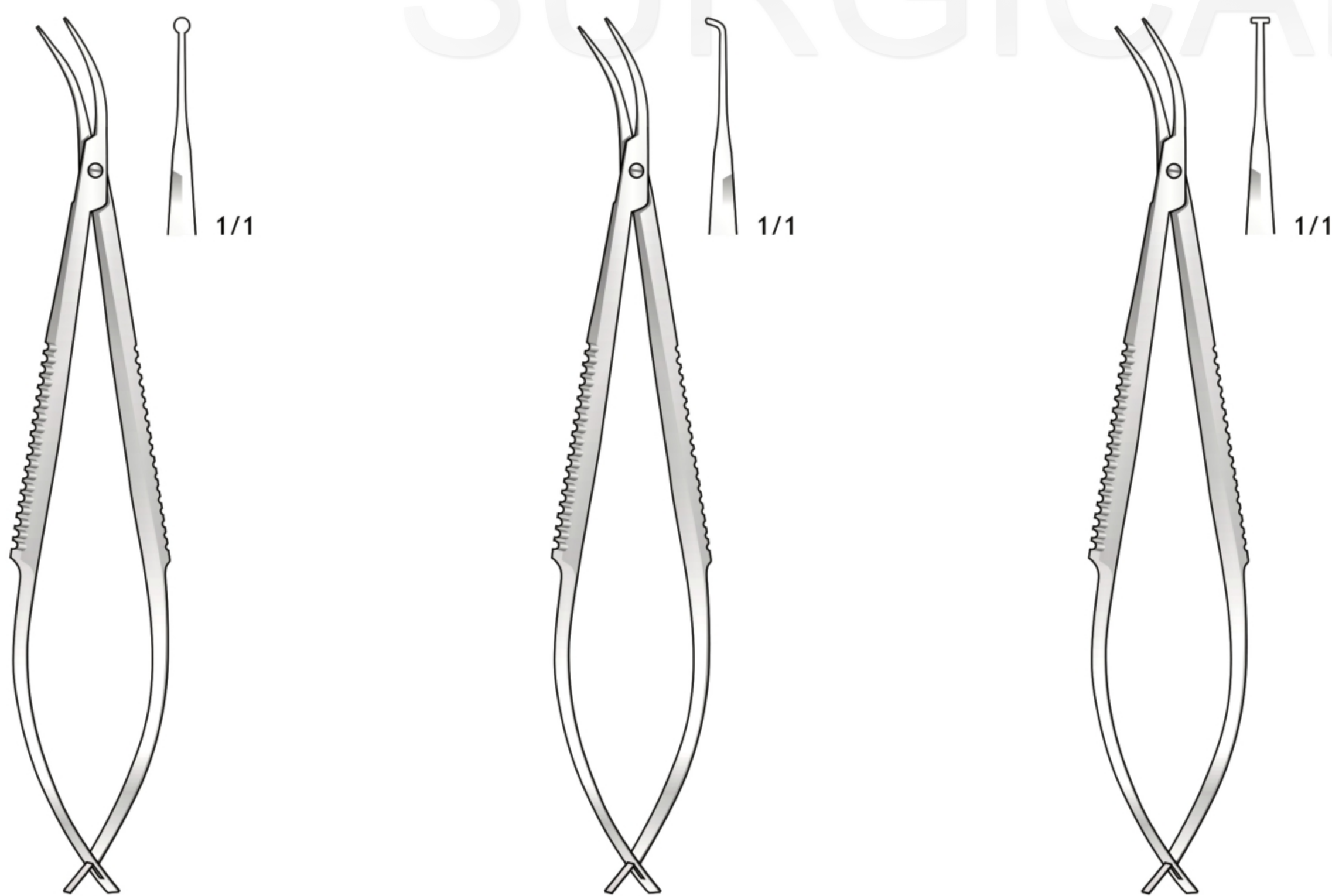

**FD 132**  
110 mm

**FD 134**  
110 mm

**FD 136**  
110 mm

Eye specula - Blefarostati - Sperrelevatoren  
Blèpharostats - Blefarostatos

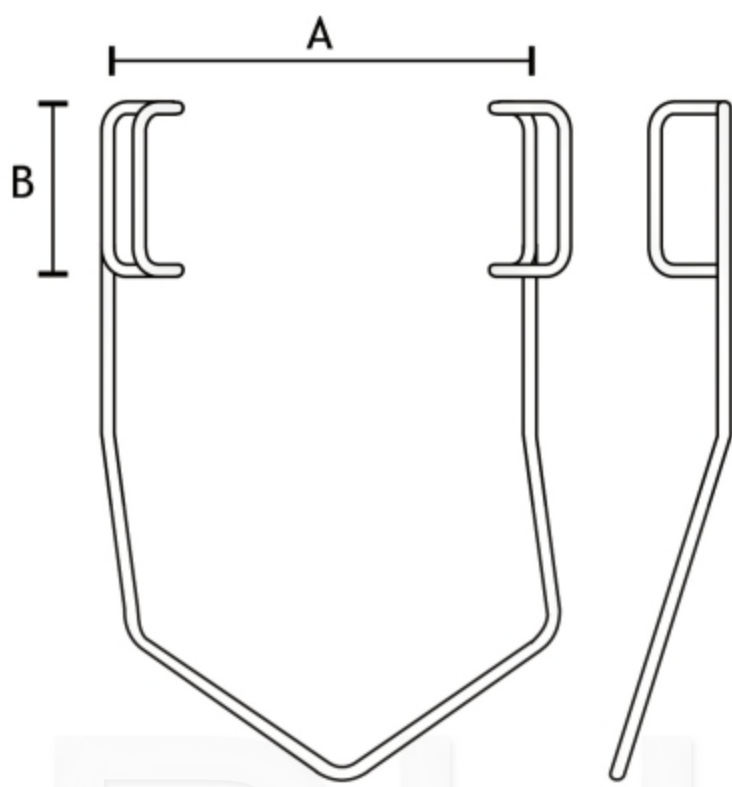

**NK 79**    A    B  
27 mm    11 mm



**BARRAQUER NK 83**

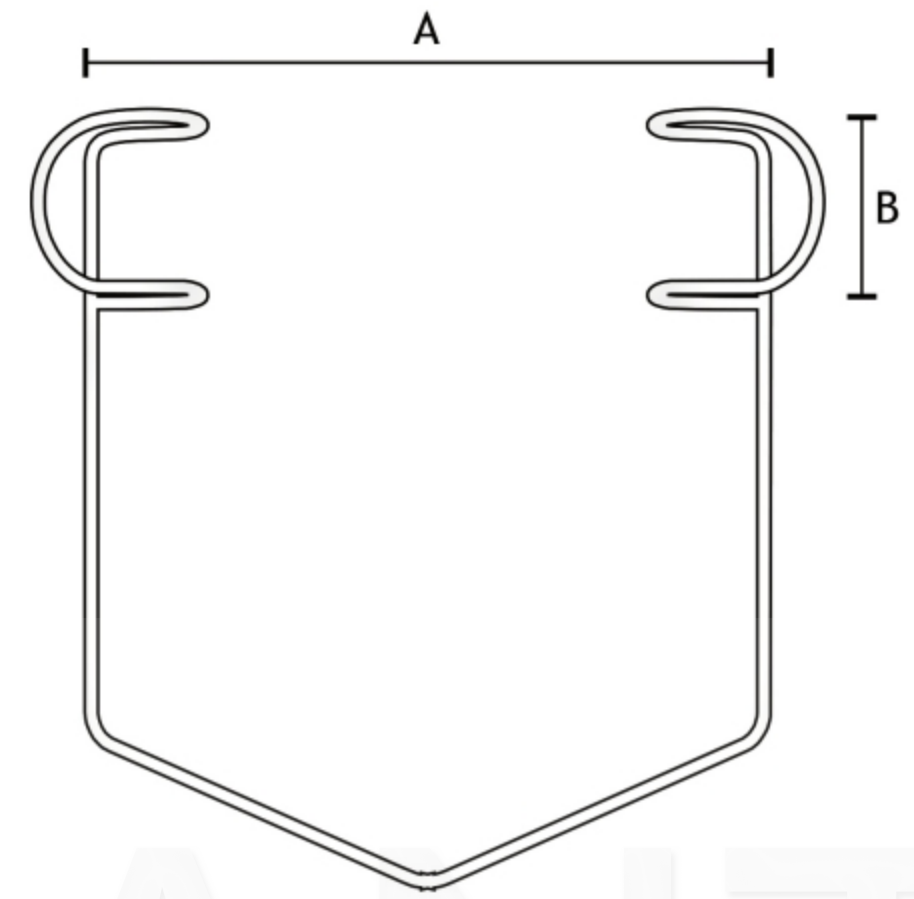

	A	B
<b>NK 80</b>	27 mm	5 mm
<b>NK 82</b>	34 mm	9 mm
<b>NK 84</b>	42 mm	12 mm
<b>NK 86</b>	42 mm	14 mm

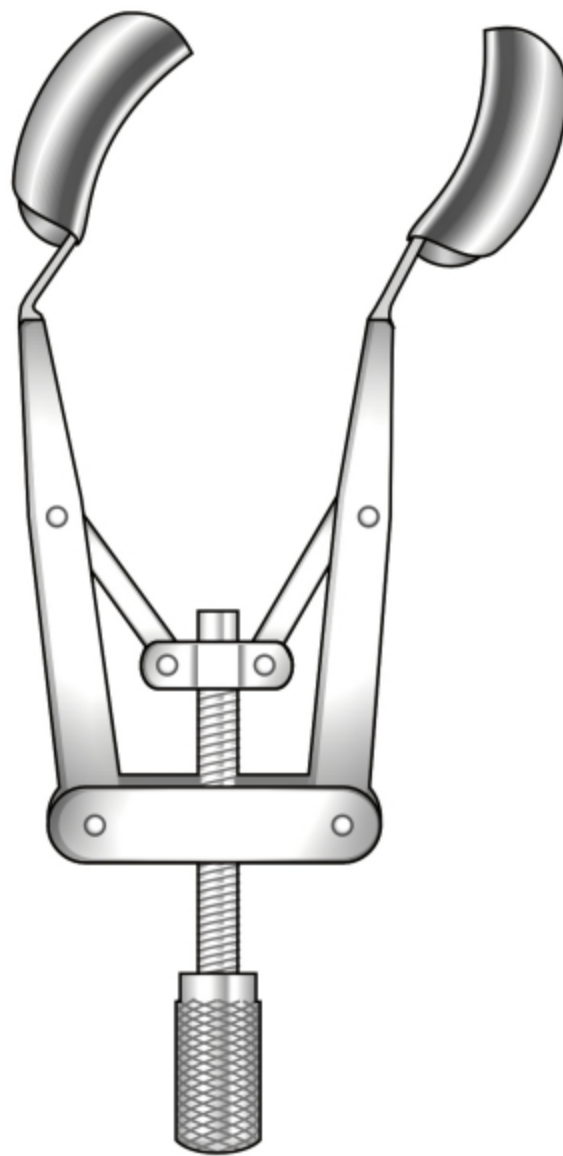

**KERSHNER NK 420**

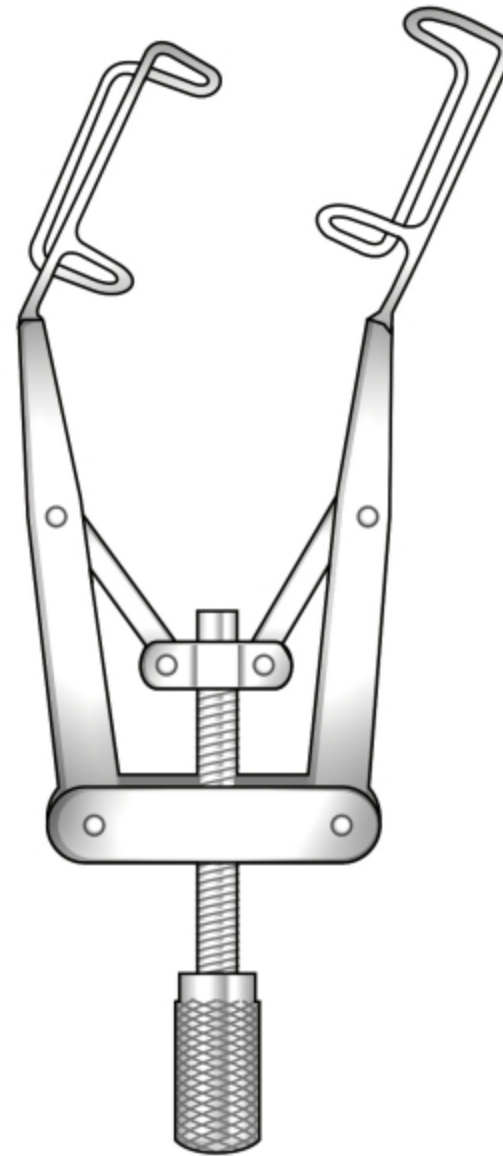

**KERSHNER NK 421**

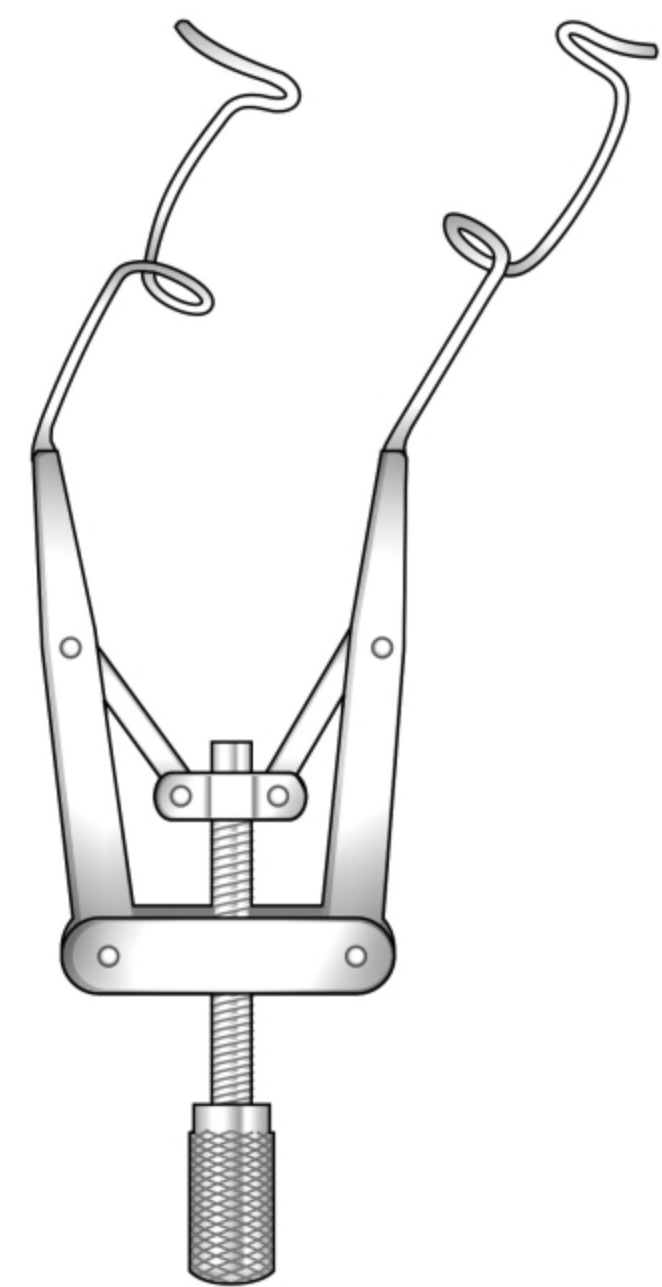

**LIEBERMANN-TENNANT NK 422**

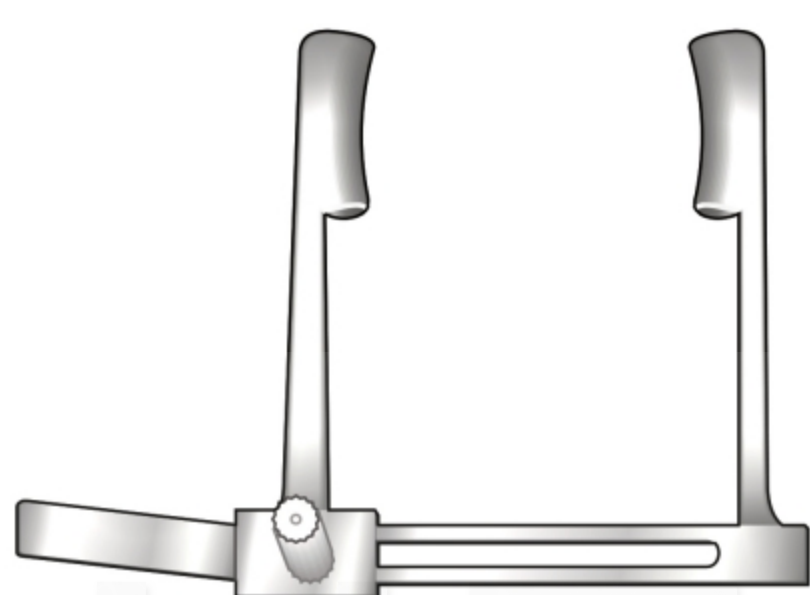

PROST  
NK 92

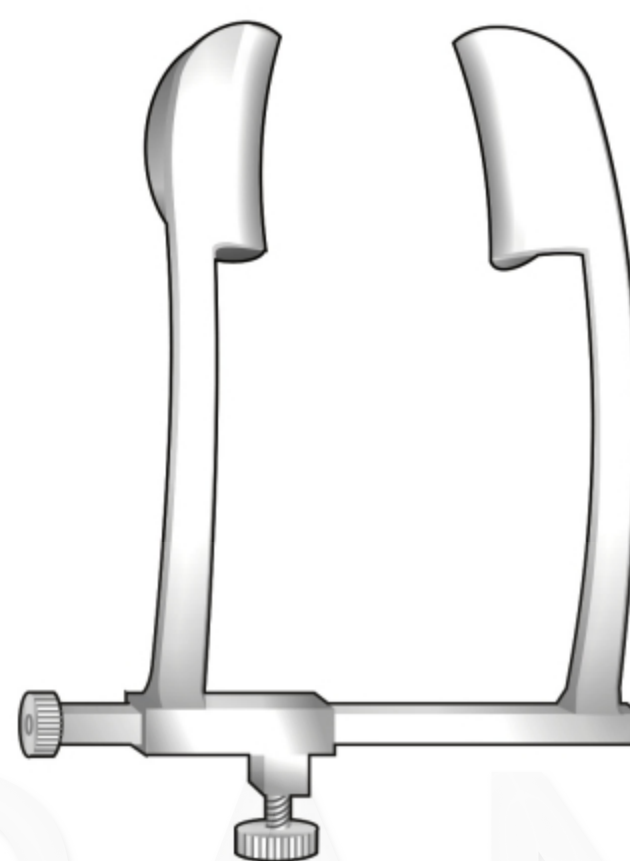

COOK  
NK 131

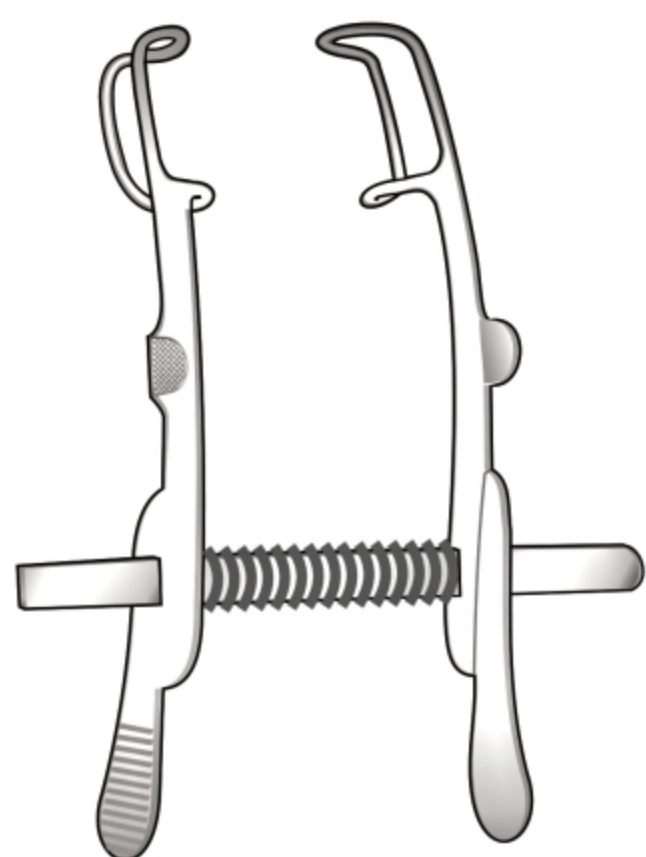

MELLINGER  
BV 02  
70 mm

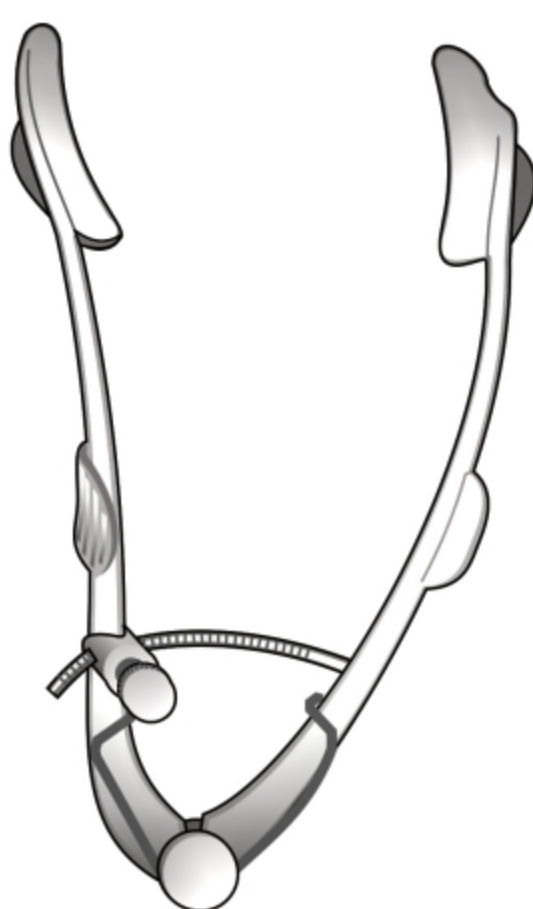

LISTER-BURCH  
BV 04  
80 mm

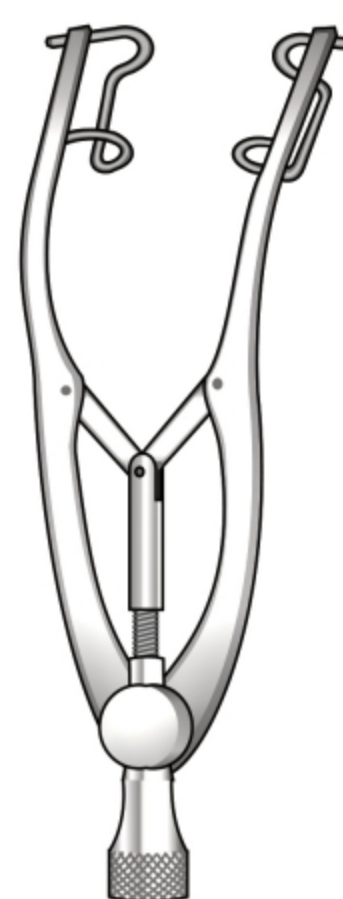

CASTROVIEJO  
BV 05  
80 mm

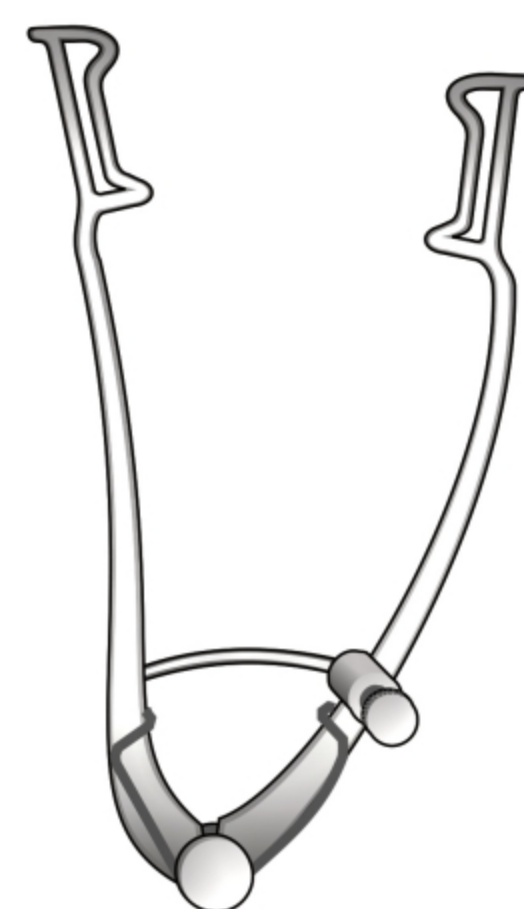

WILLIAMS  
BV 06  
80 mm

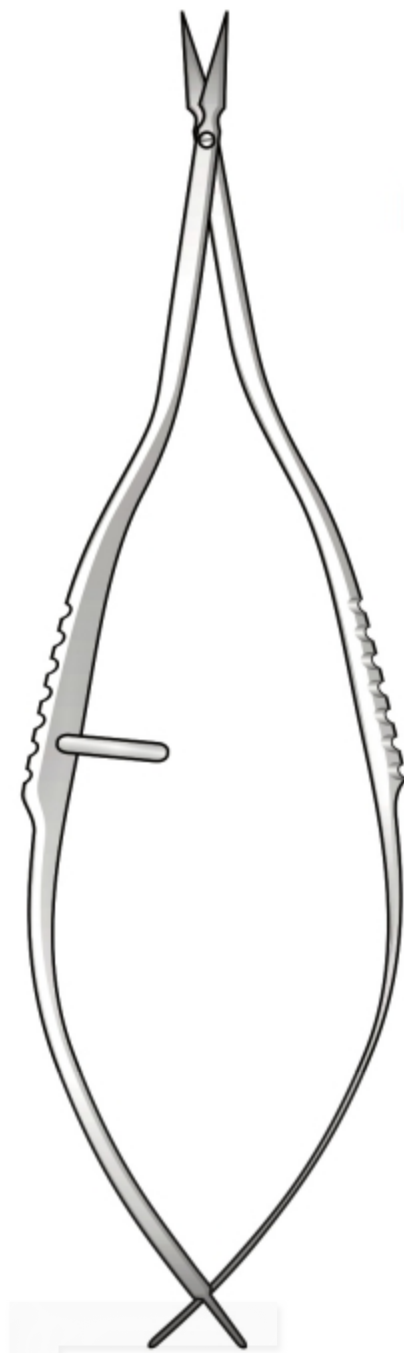

VANNAS  
FD 79/FD 81  
85 mm

PHEASANT<sup>®</sup>  
SURGICAL

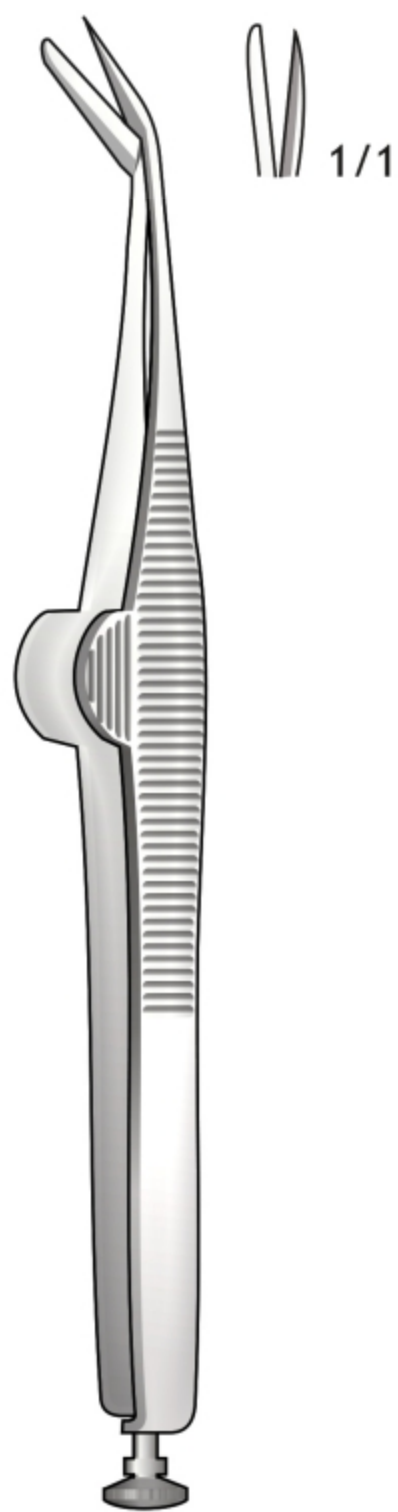

WECKER  
FD 231  
110 mm

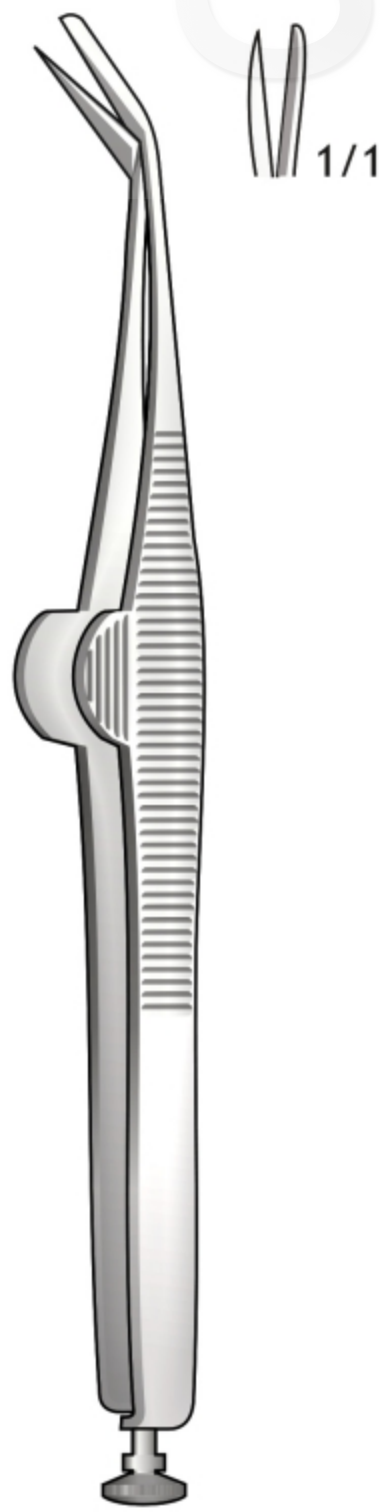

WECKER  
FD 232  
110 mm

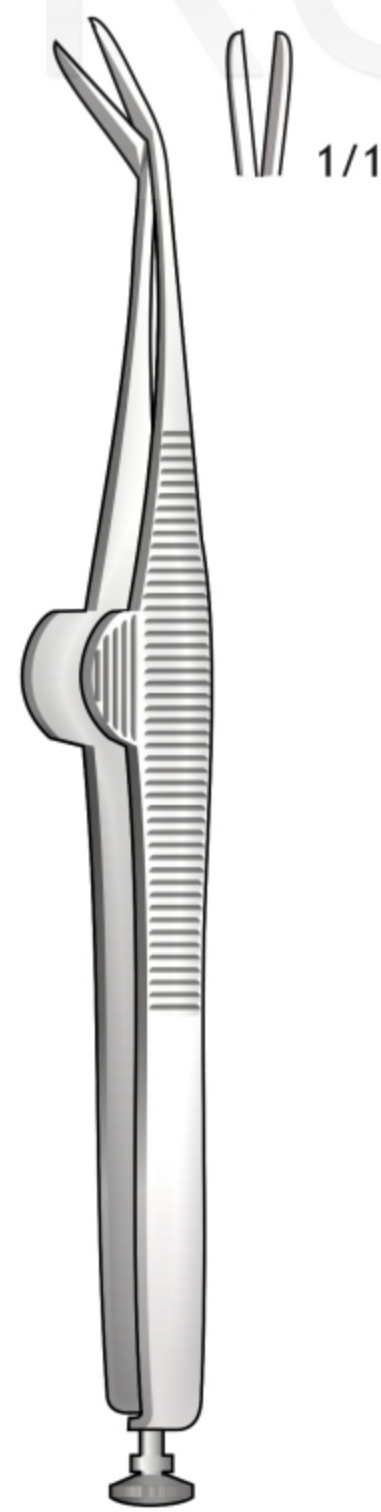

WECKER  
FD 233  
110 mm

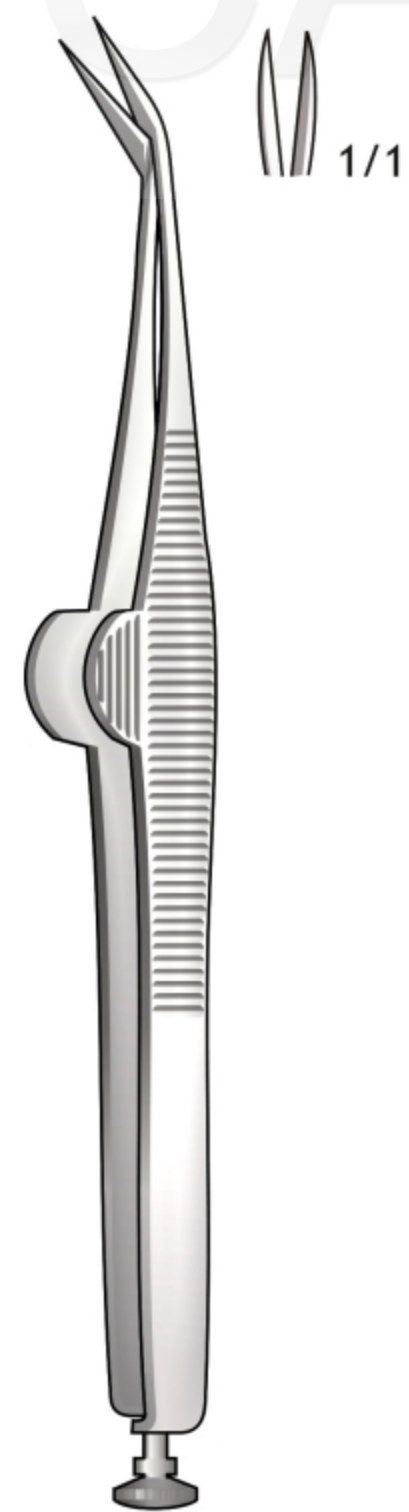

WECKER  
FD 234  
110 mm

Sharp - Acuta - Spitz  
Pointu - Agudas



NOYES  
FD 10  
120 mm

Sharp - Acuta - Spitz  
Pointu - Agudas



NOYES  
FD 12  
120 mm

Sharp - Acuta - Spitz  
Pointu - Agudas



WESTCOTT  
FD 13  
120 mm

Sharp - Acuta - Spitz  
Pointu - Agudas

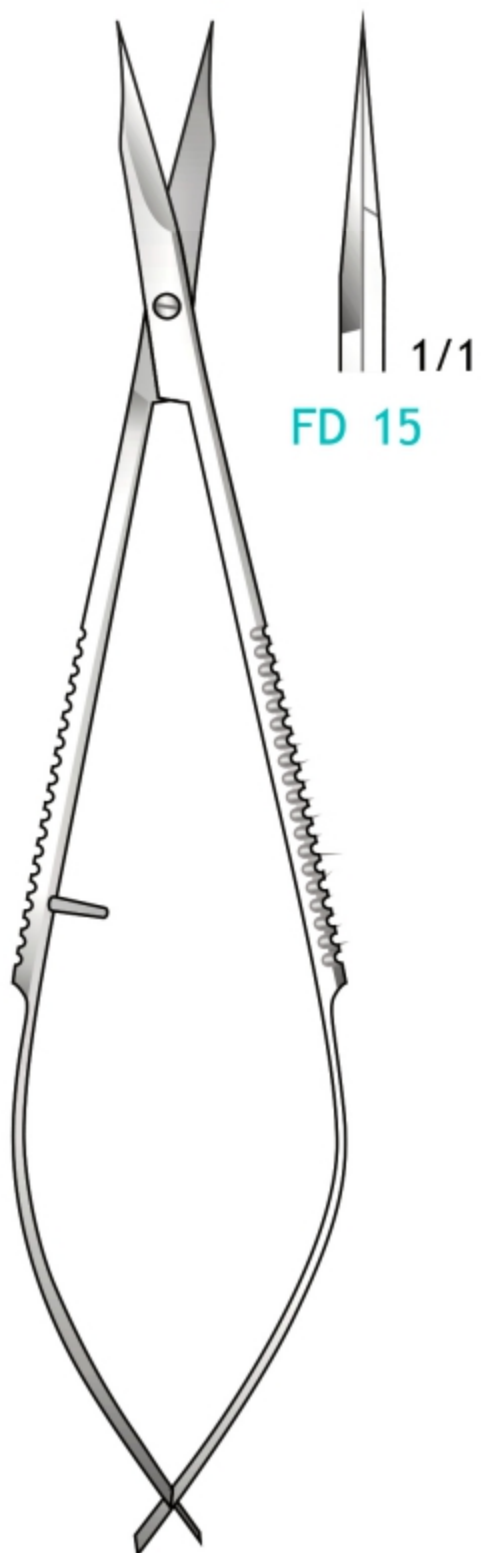

WESTCOTT  
FD 15  
120 mm

Blunt - Smussa - Stumpf  
Mousse - Romas



WESTCOTT  
FD 64  
120 mm

Blunt - Smussa - Stumpf  
Mousse - Romas

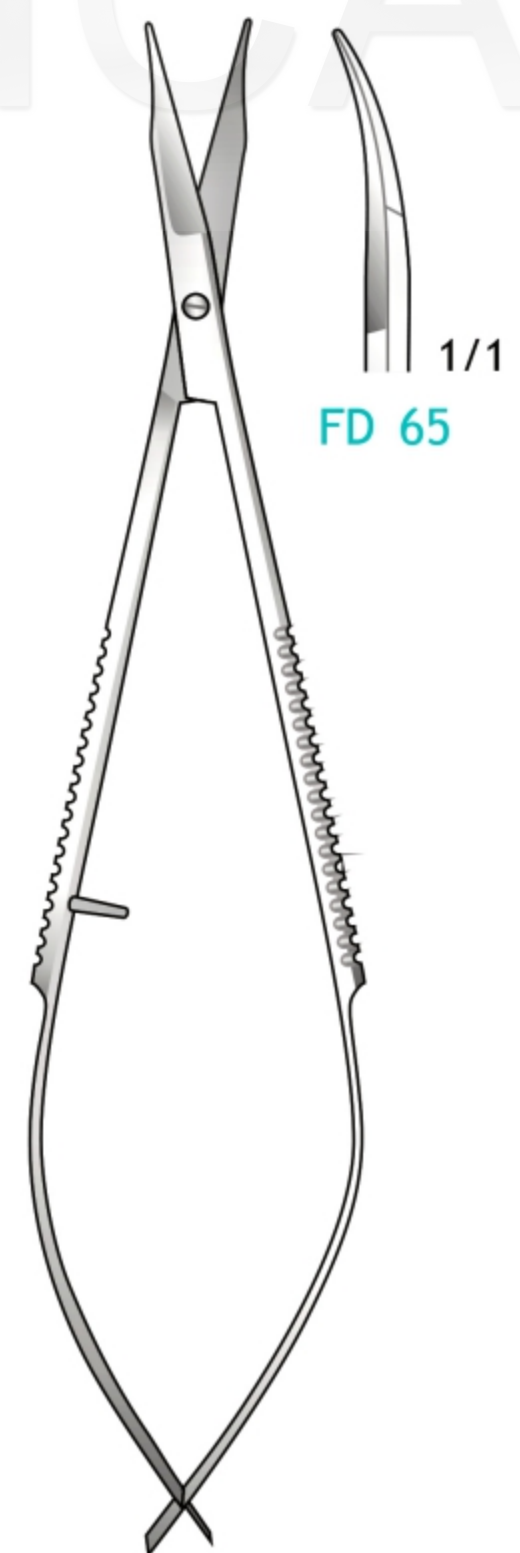

WESTCOTT  
FD 65  
120 mm

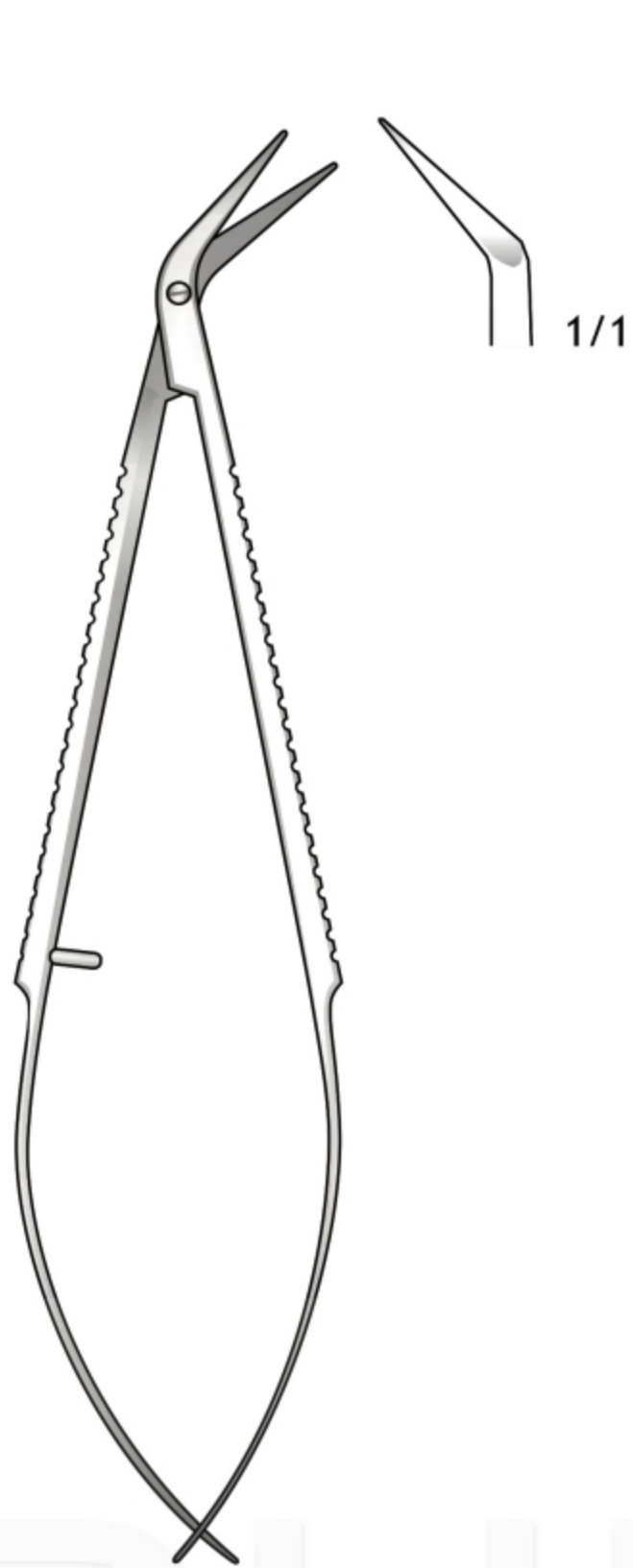

**FD 03**  
110 mm

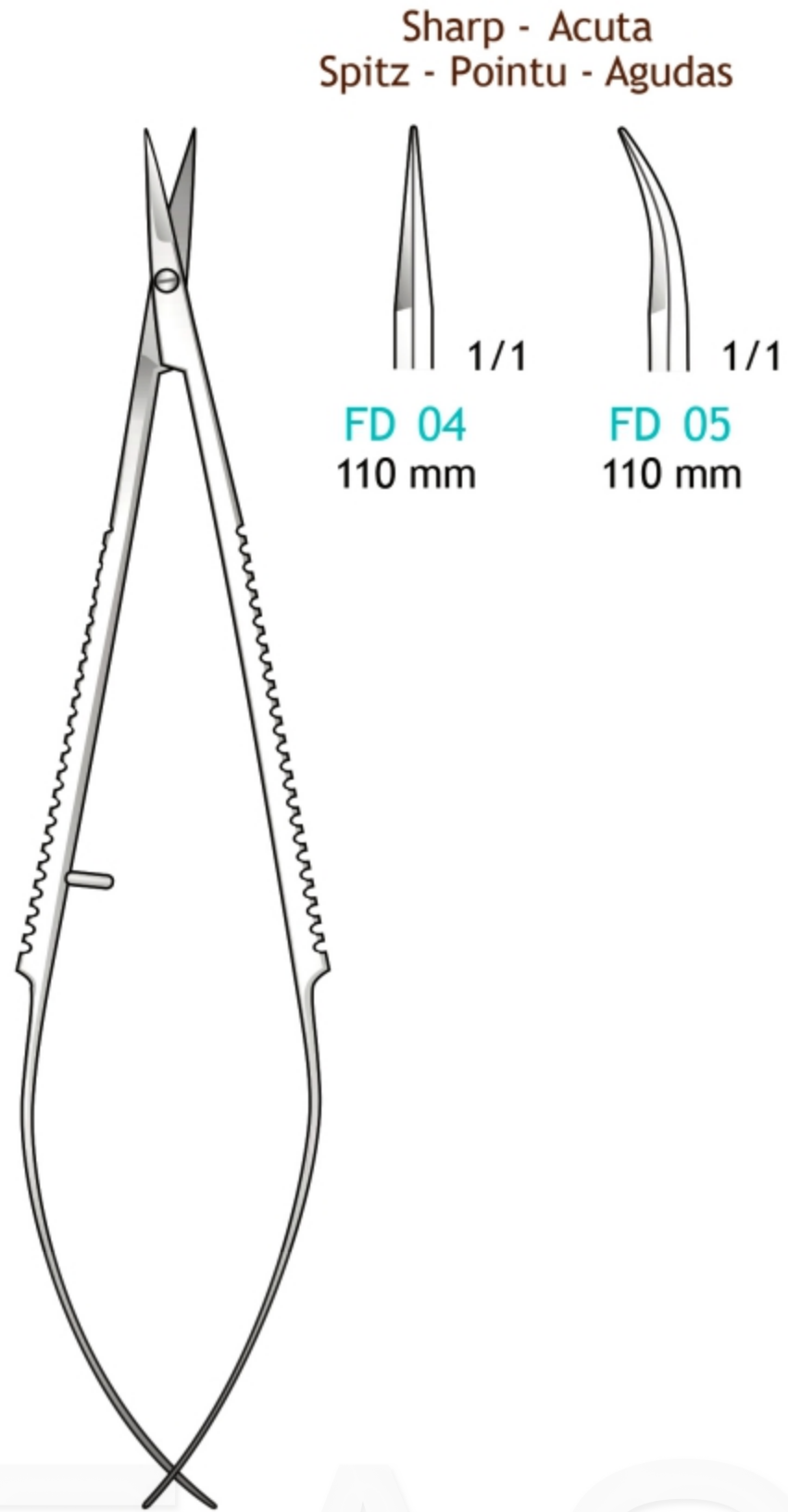

**FD 04**  
110 mm

**FD 05**  
110 mm

**FD 04/FD 05**  
110 mm

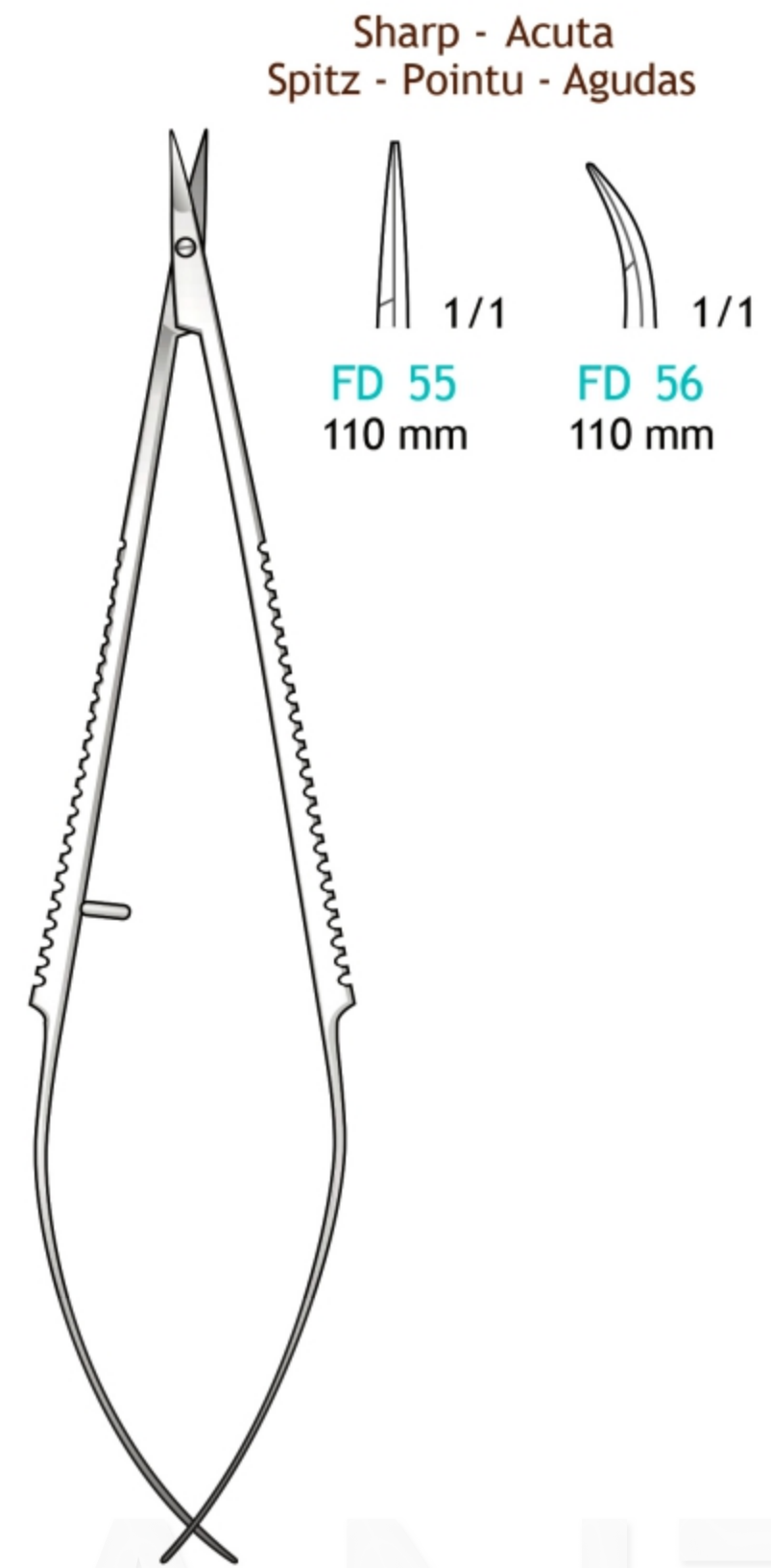

**FD 55**  
110 mm

**FD 56**  
110 mm

**FD 55/FD 56**  
110 mm

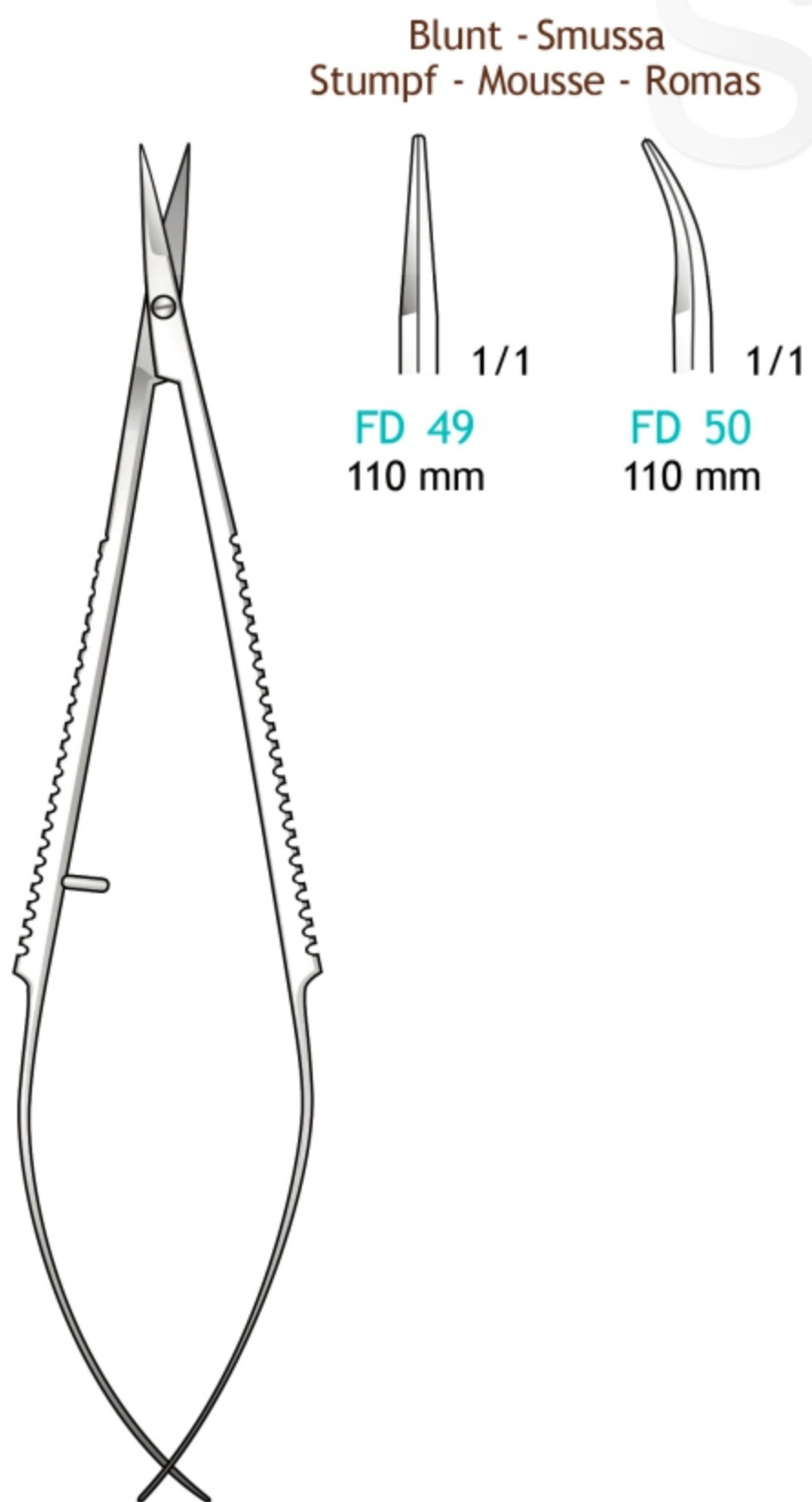

**FD 49**  
110 mm

**FD 50**  
110 mm

**FD 49/FD 50**  
110 mm

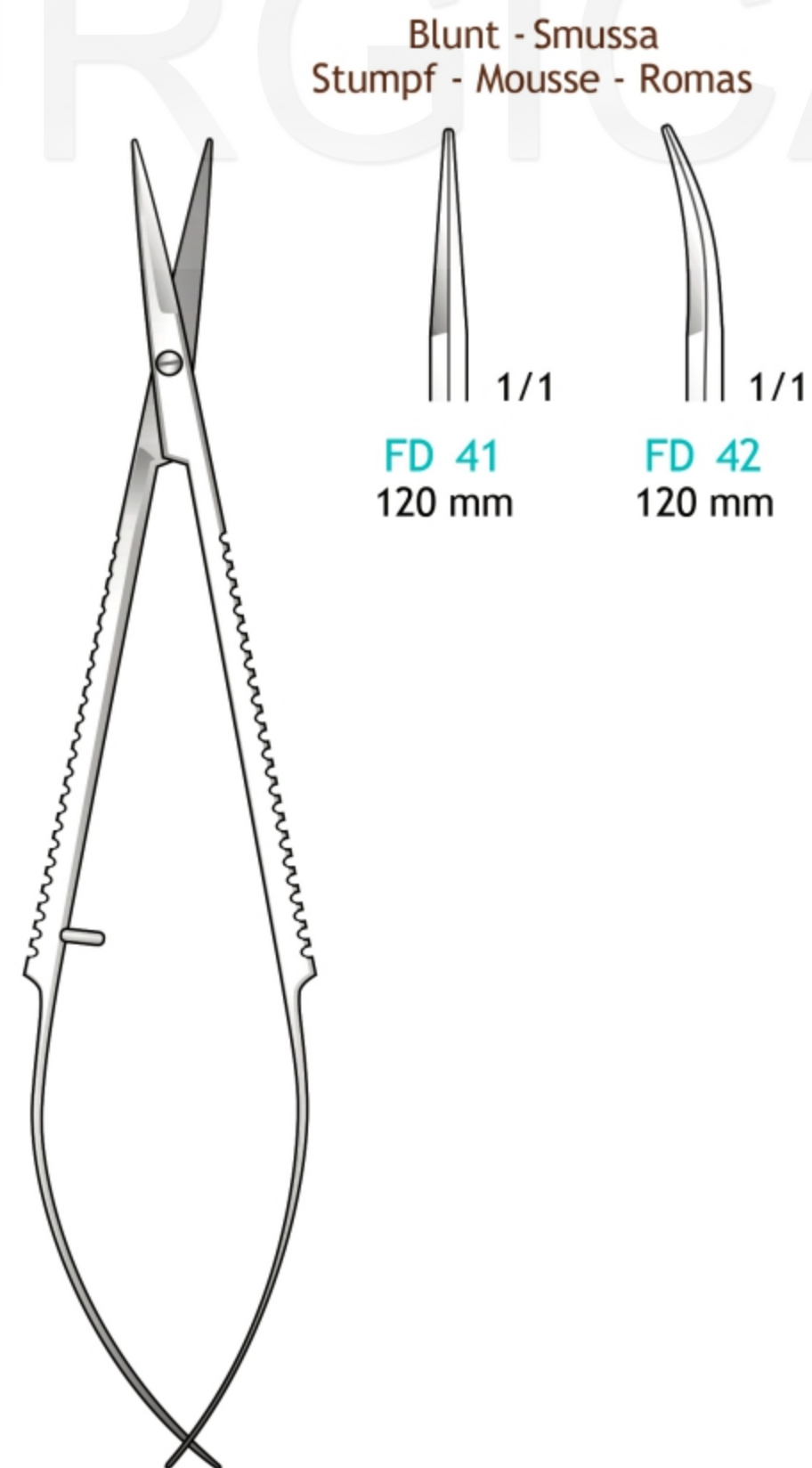

**FD 41**  
120 mm

**FD 42**  
120 mm

**FD 41/FD 42**  
120 mm



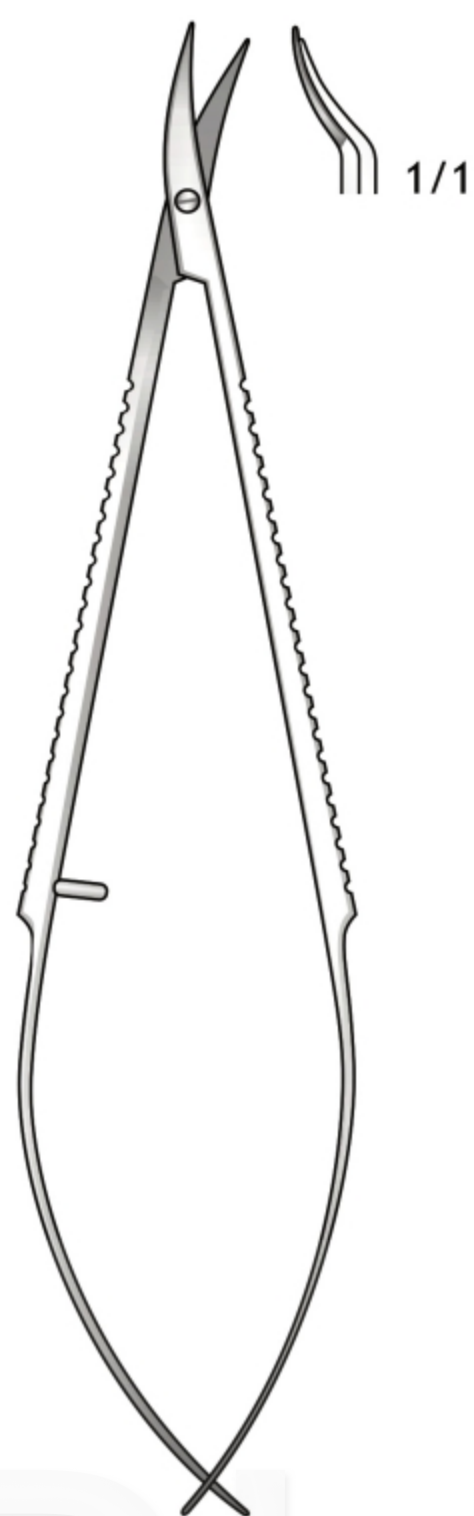

TROUTMAN  
FD 69  
110 mm

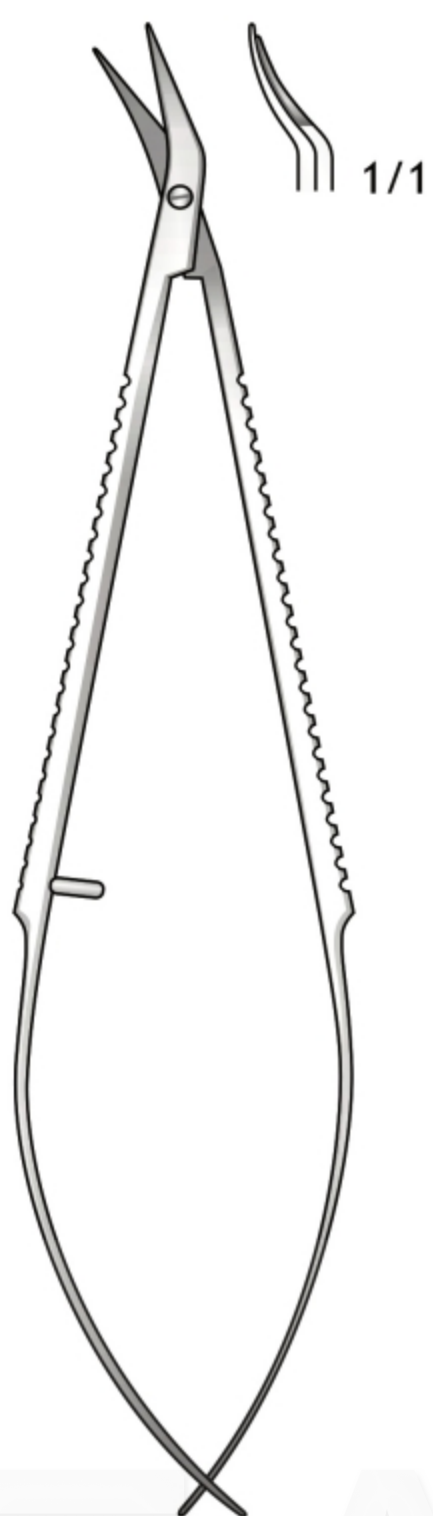

TROUTMAN  
FD 70  
110 mm

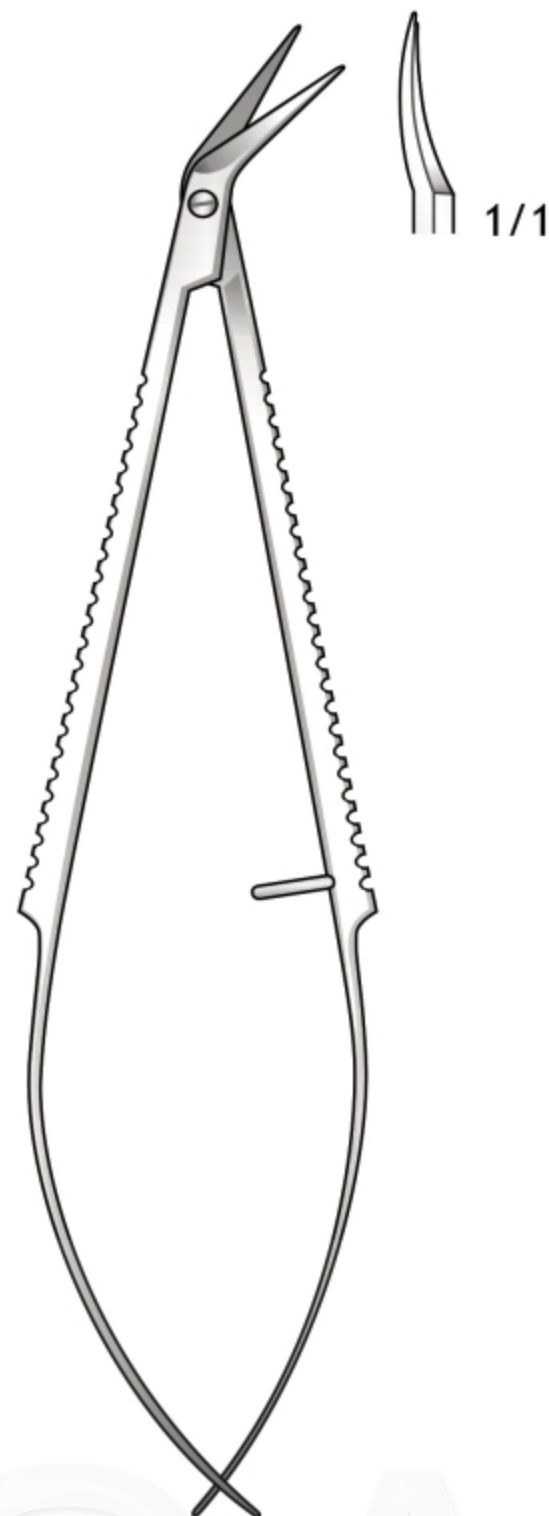

CASTROVIEJO  
FD 66  
110 mm

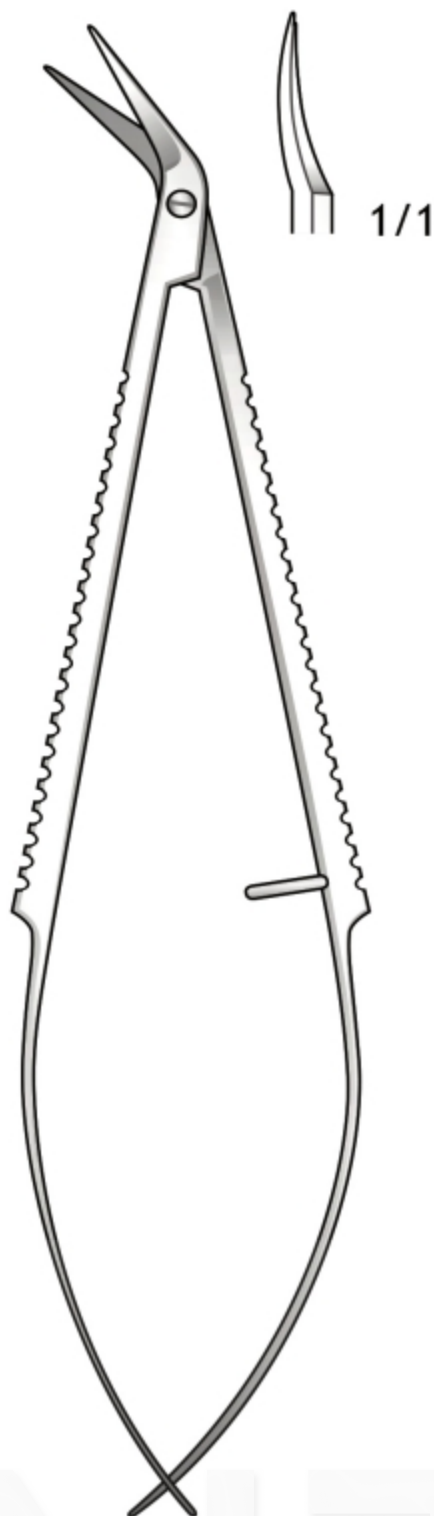

CASTROVIEJO  
FD 67  
110 mm

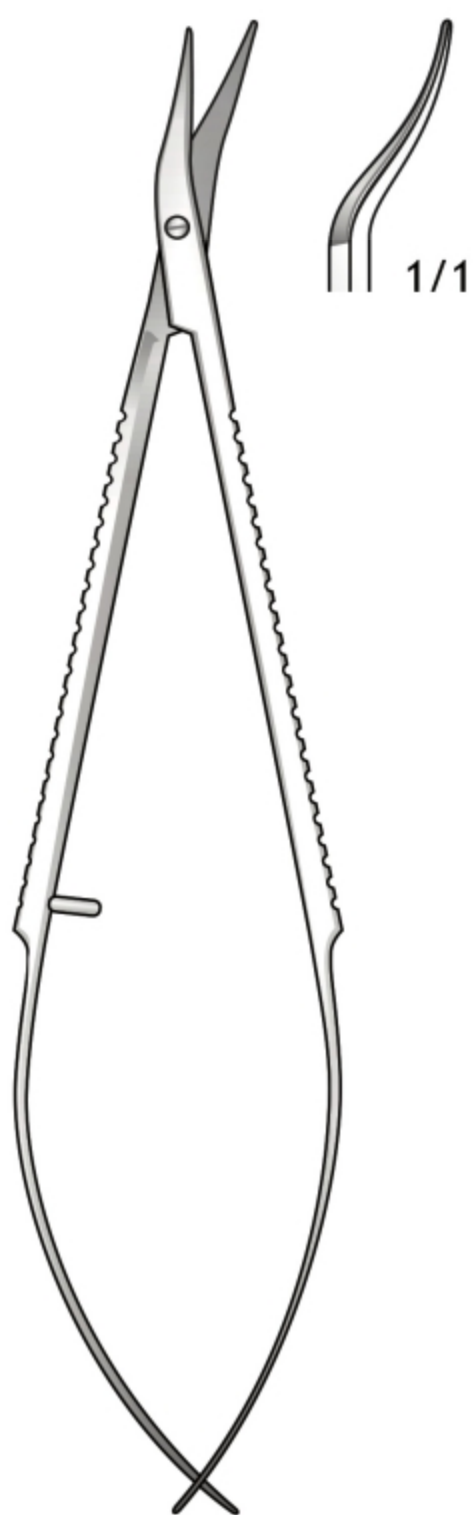

CASTROVIEJO  
FD 68  
110 mm

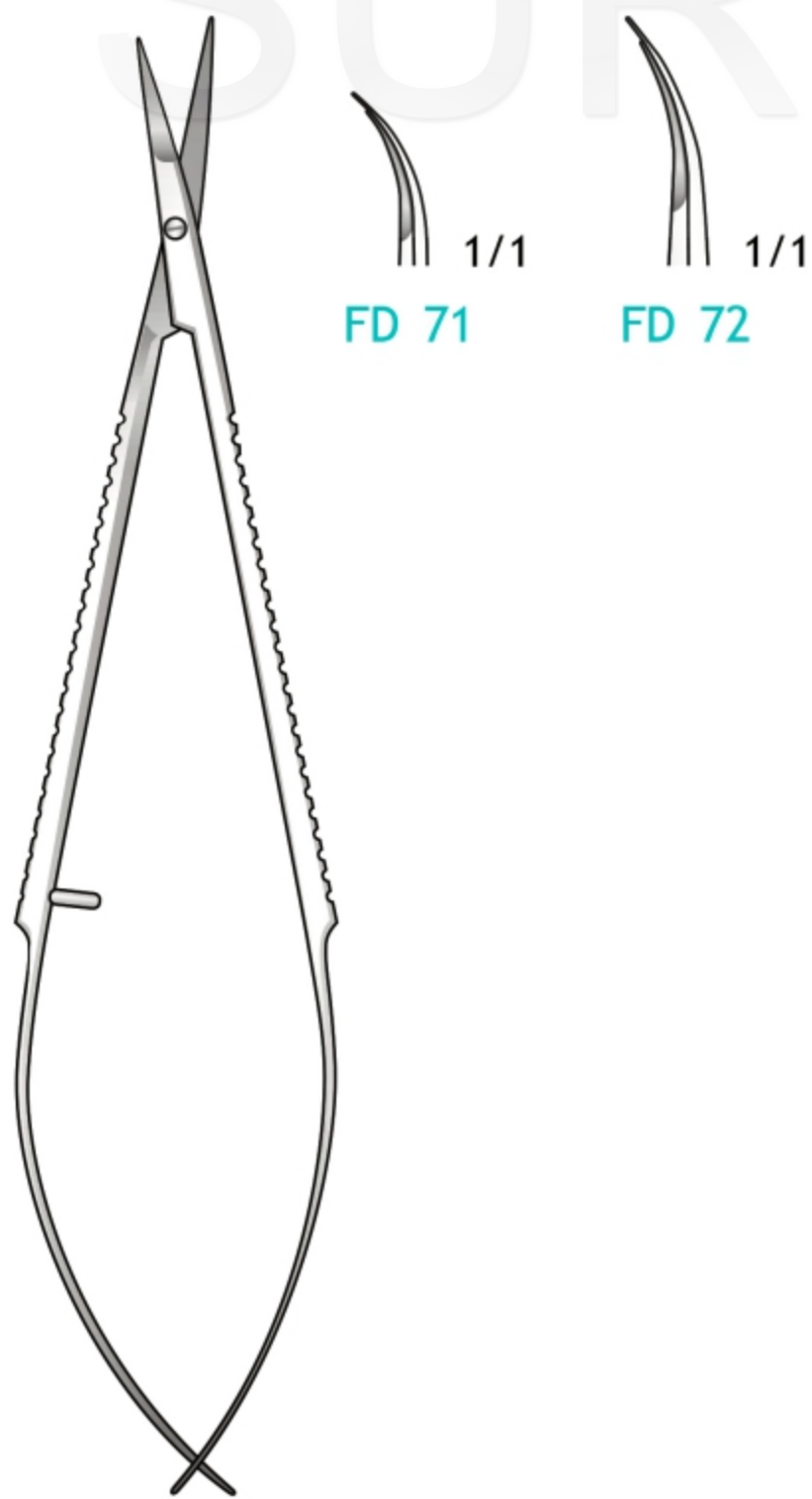

FD 71/FD 72  
110 mm

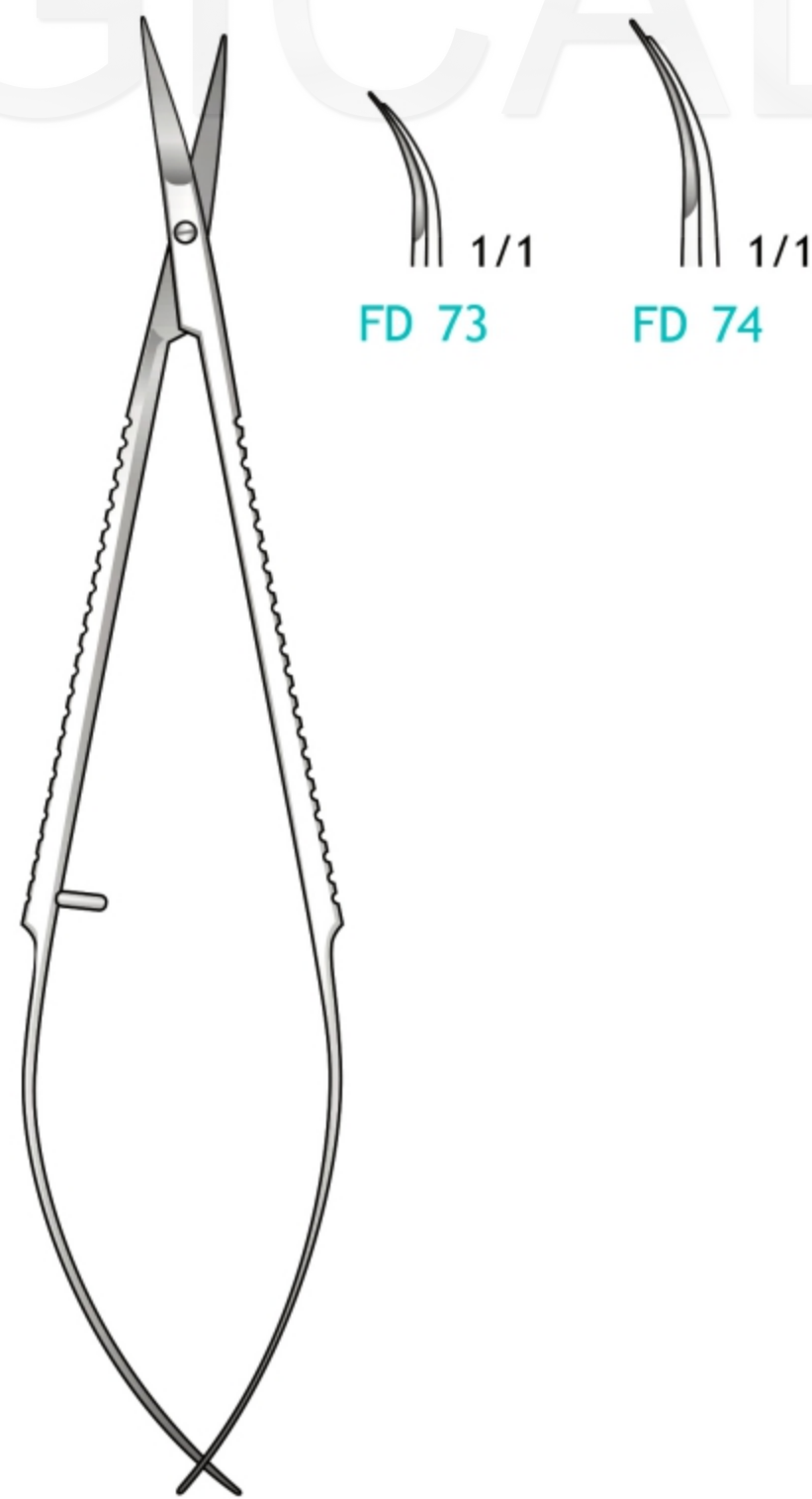

FD 73/FD 74  
110 mm

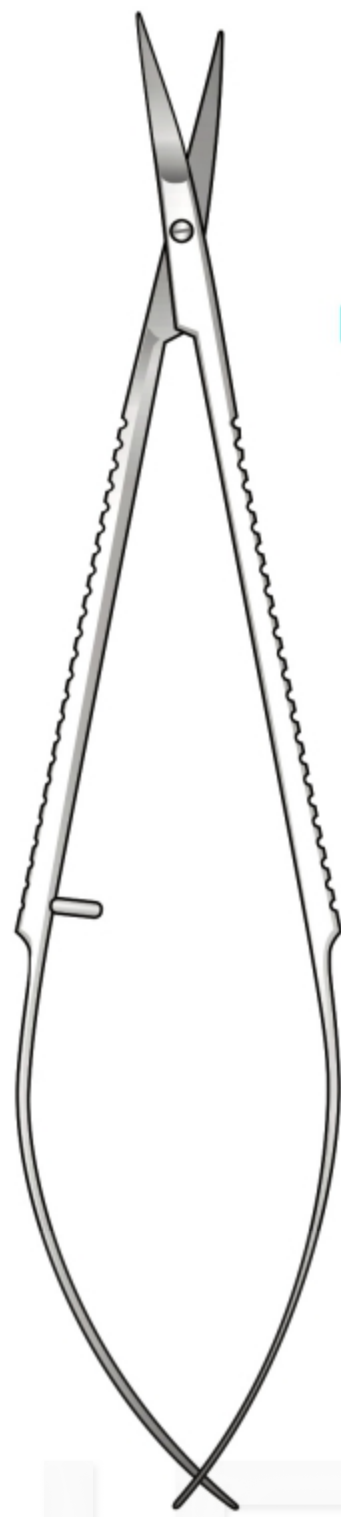

FD 146  
110 mm



FD 147  
115 mm

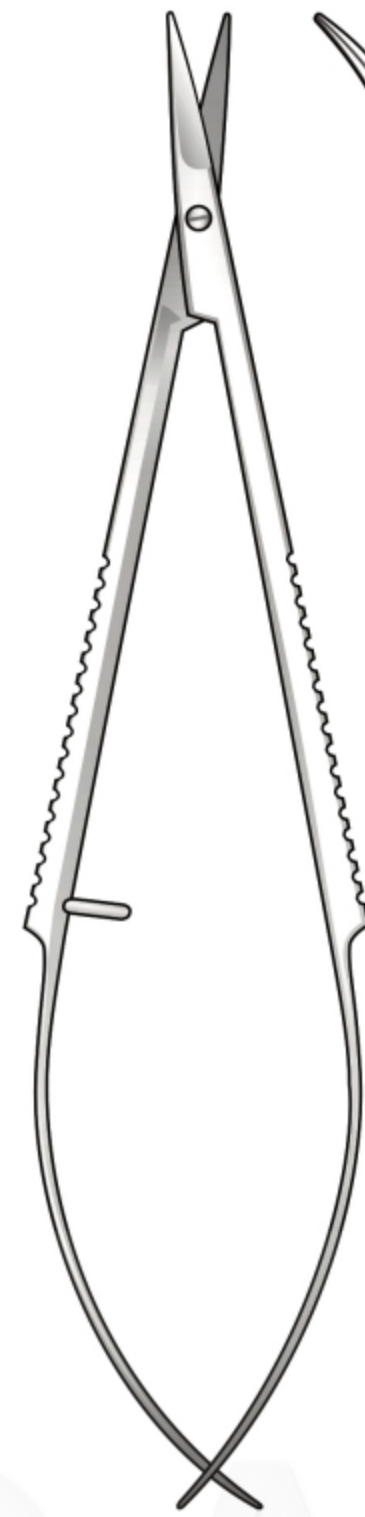

FD 62  
110 mm



FD 146/FD 147

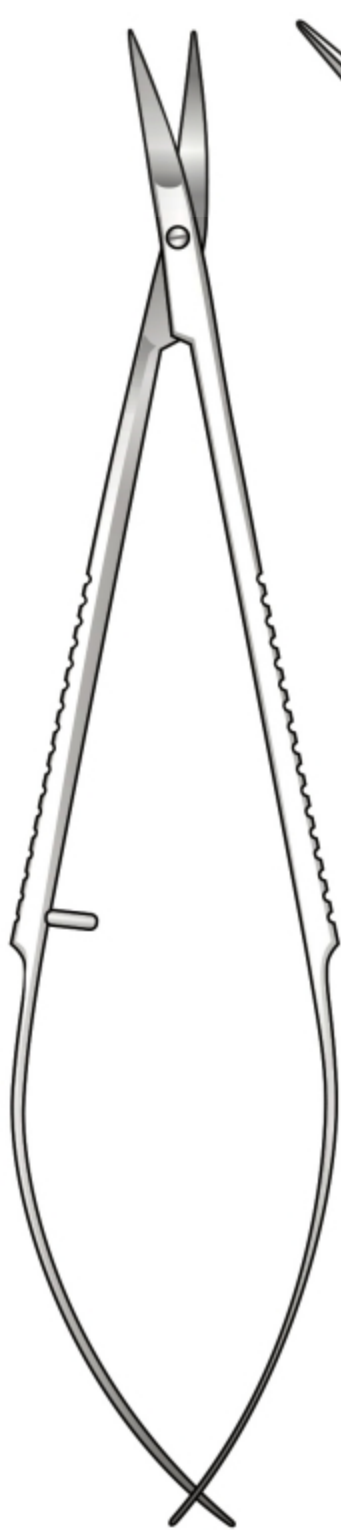

FD 11  
110 mm

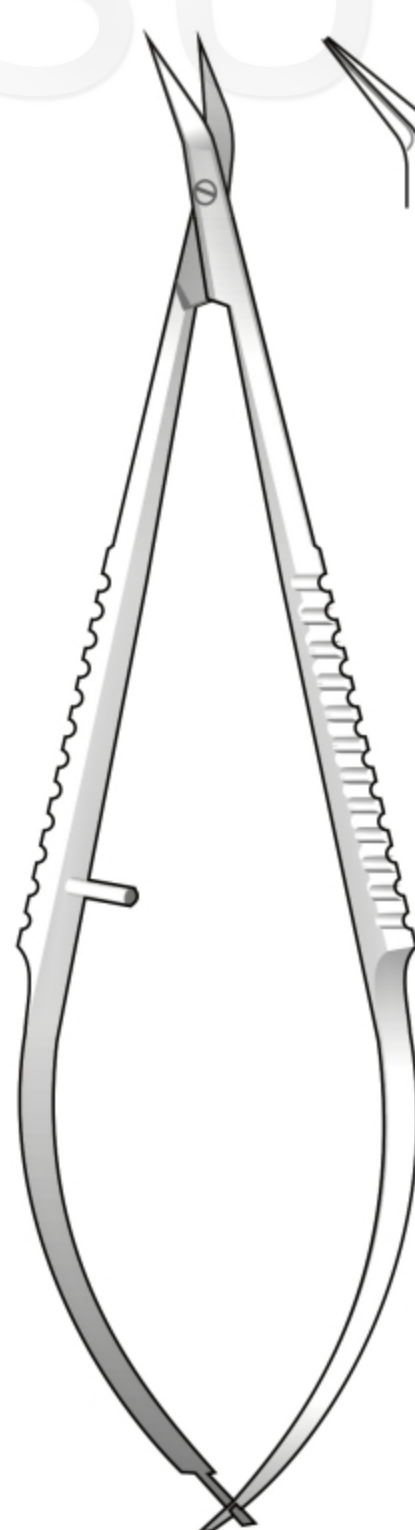
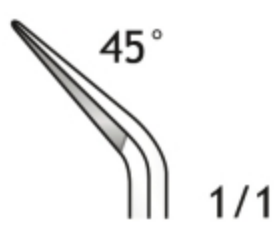

FD 235  
110 mm

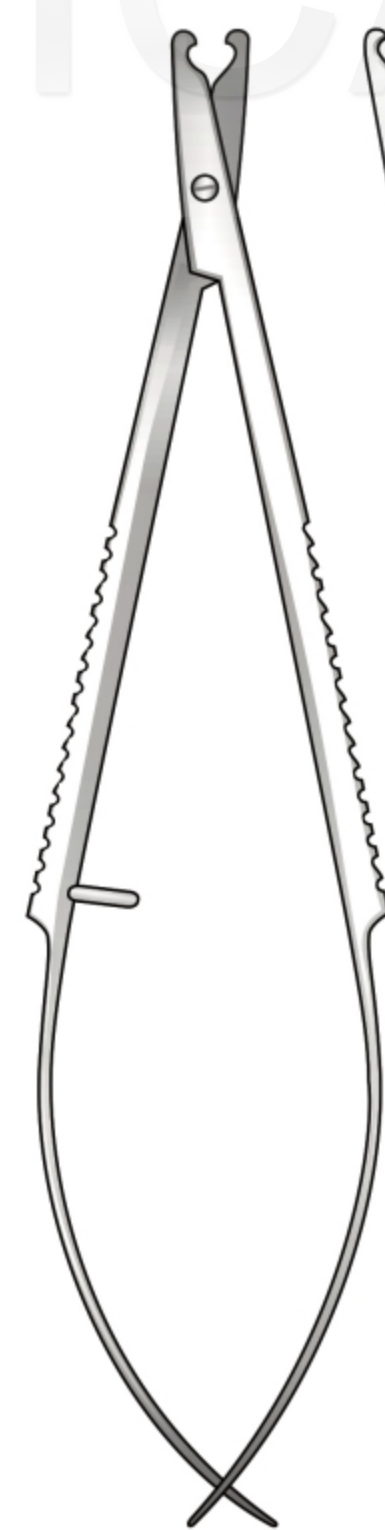

FD 61  
110 mm



PHEASANT<sup>®</sup>  
SURGICAL

Sharp - Acuta - Spitz - Pointu - Agudas

Sharp - Acuta - Spitz - Pointu - Agudas

Blunt - Smussa - Stumpf - Mousse - Romas

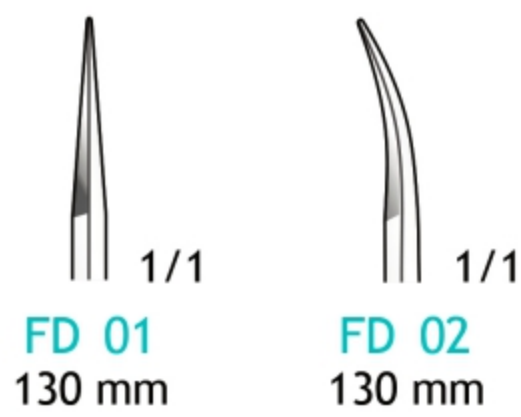
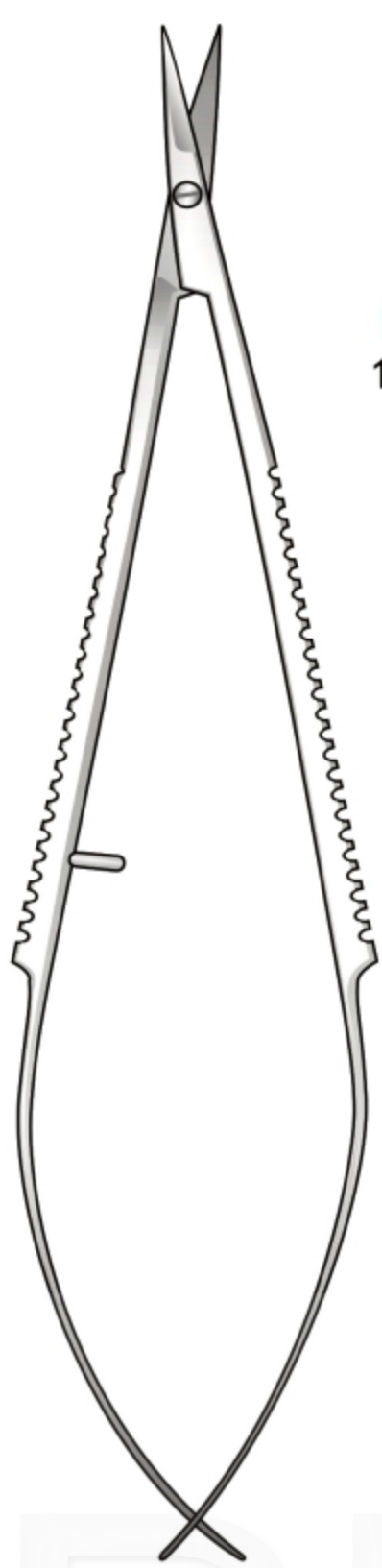

FD 01/FD 02  
130 mm

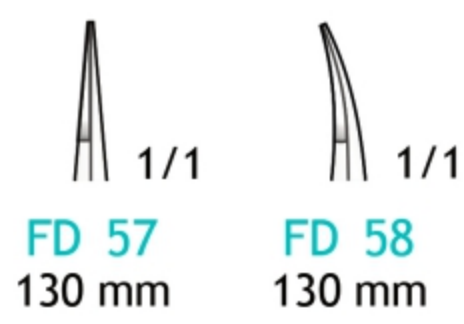
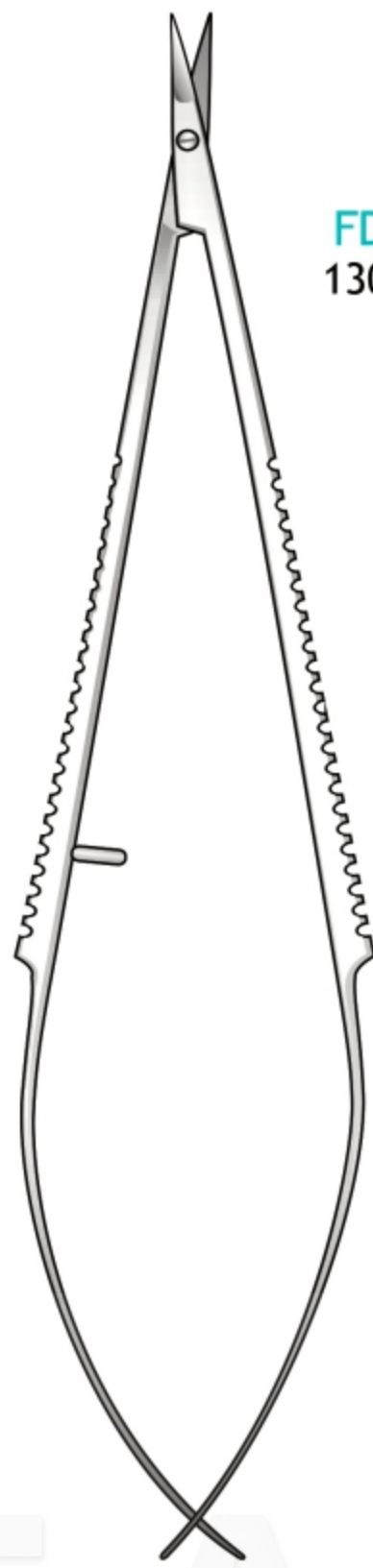

FD 57/FD 58  
130 mm

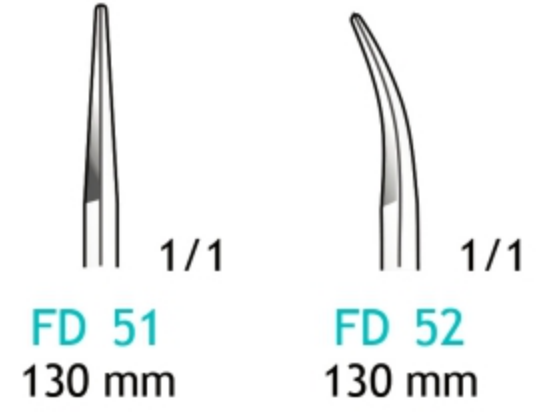
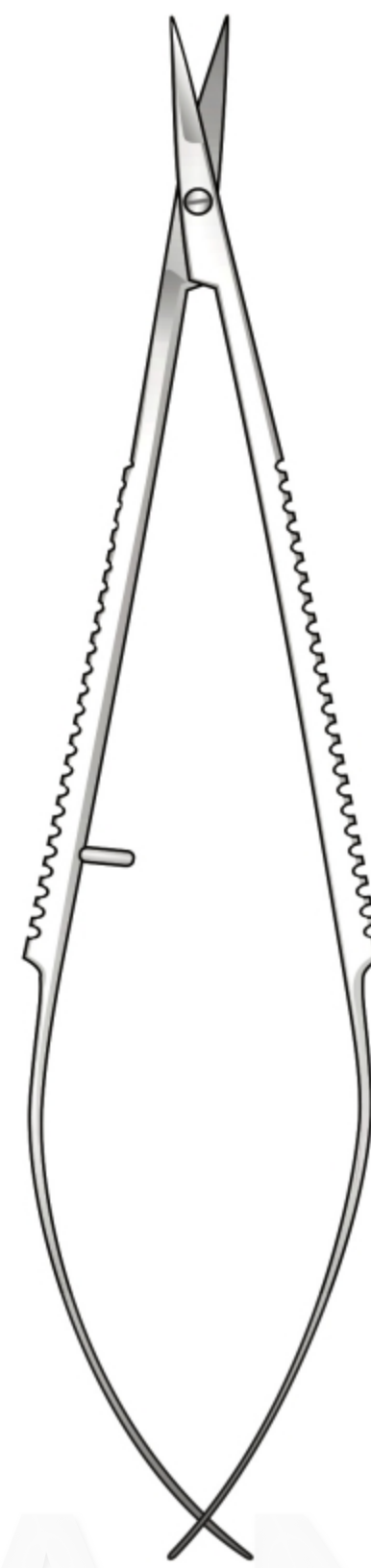

FD 51/FD 52  
130 mm

Sharp - Acuta - Spitz - Pointu - Agudas

Blunt - Smussa - Stumpf - Mousse - Romas

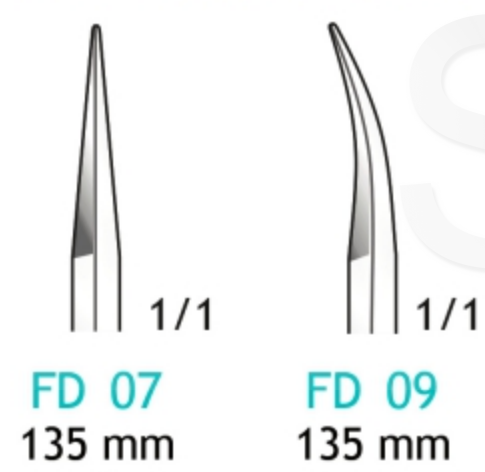
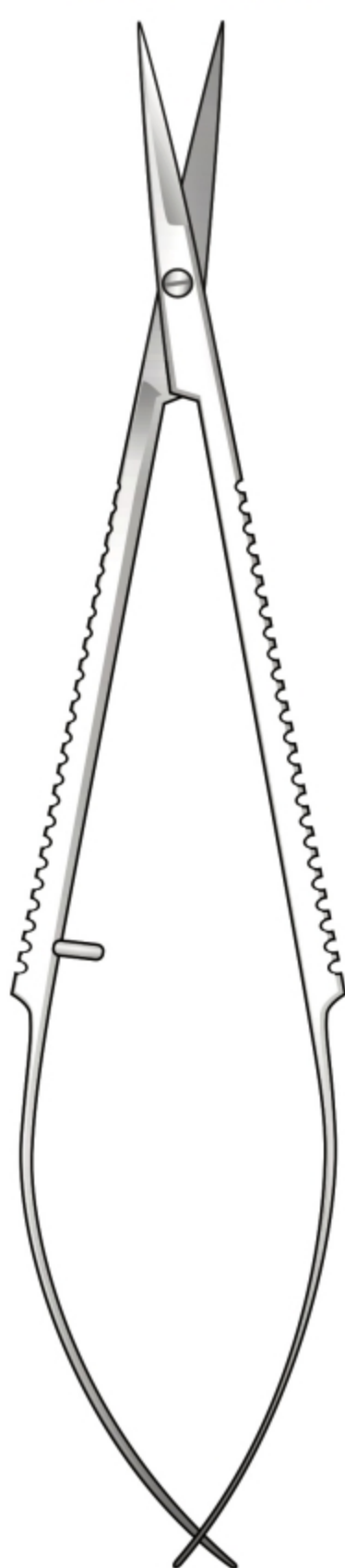

FD 07/FD 09  
135 mm

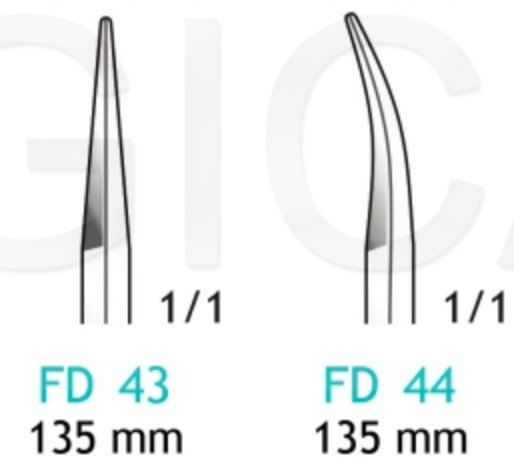
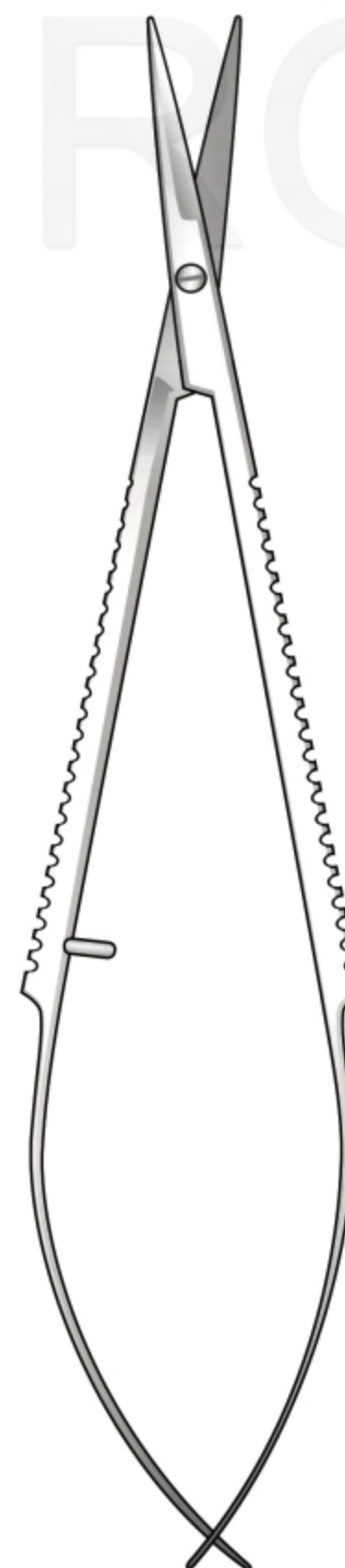

FD 43/FD 44  
135 mm

Sharp - Acuta  
Spitz - Pointu - Agudas

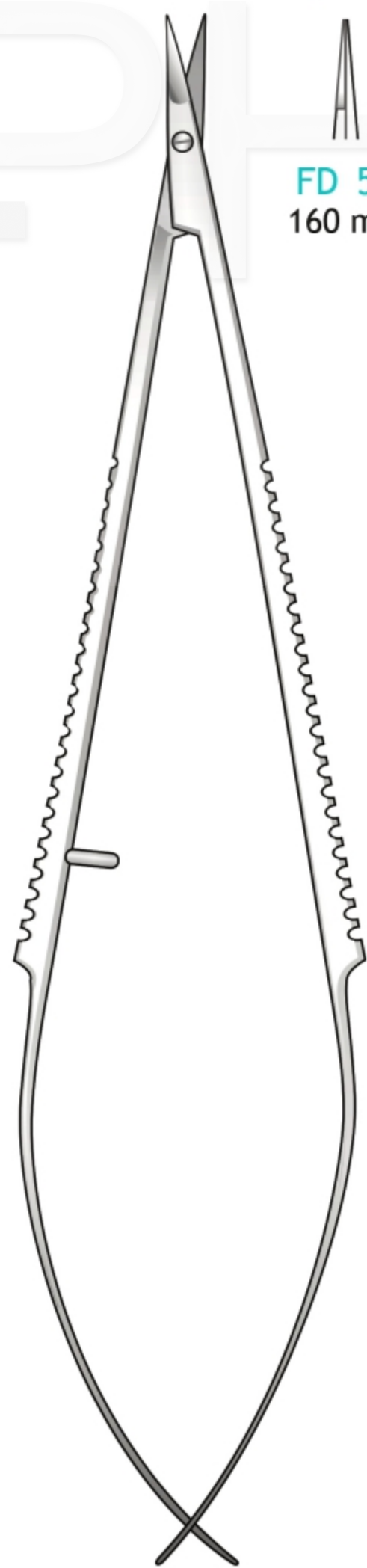

 1/1  
**FD 59**  
160 mm

 1/1  
**FD 60**  
160 mm

**FD 59/FD 60**  
160 mm

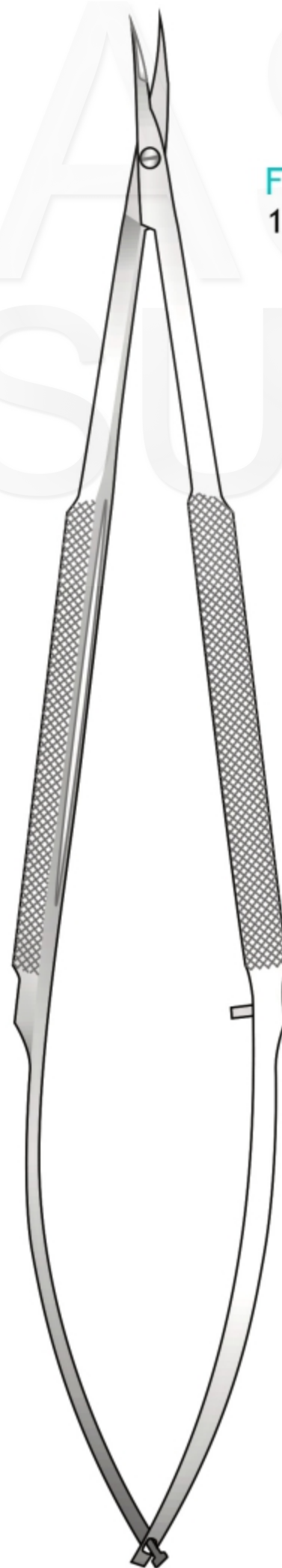

 1/1  
**FD 137**  
150 mm

 1/1  
**FD 138**  
150 mm

**FD 137/FD 138**  
150 mm

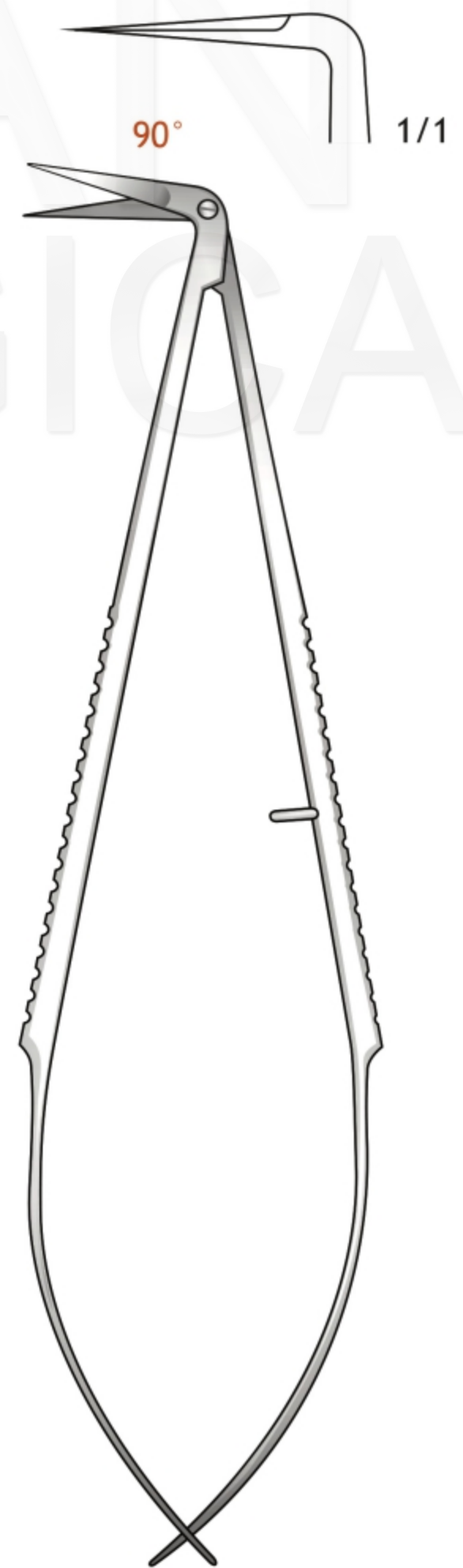

90° 1/1

**FD 40**  
150 mm

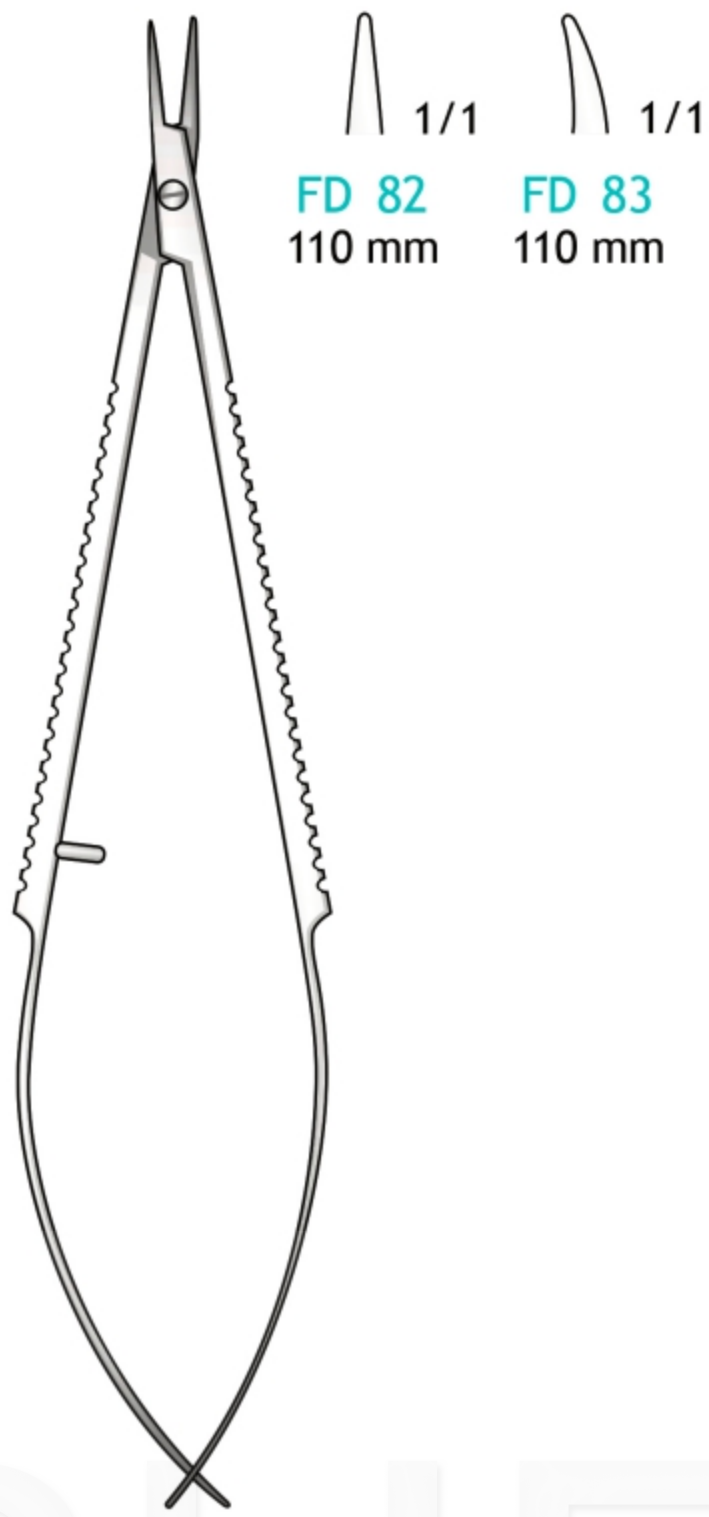

FD 82/FD 83  
110 mm

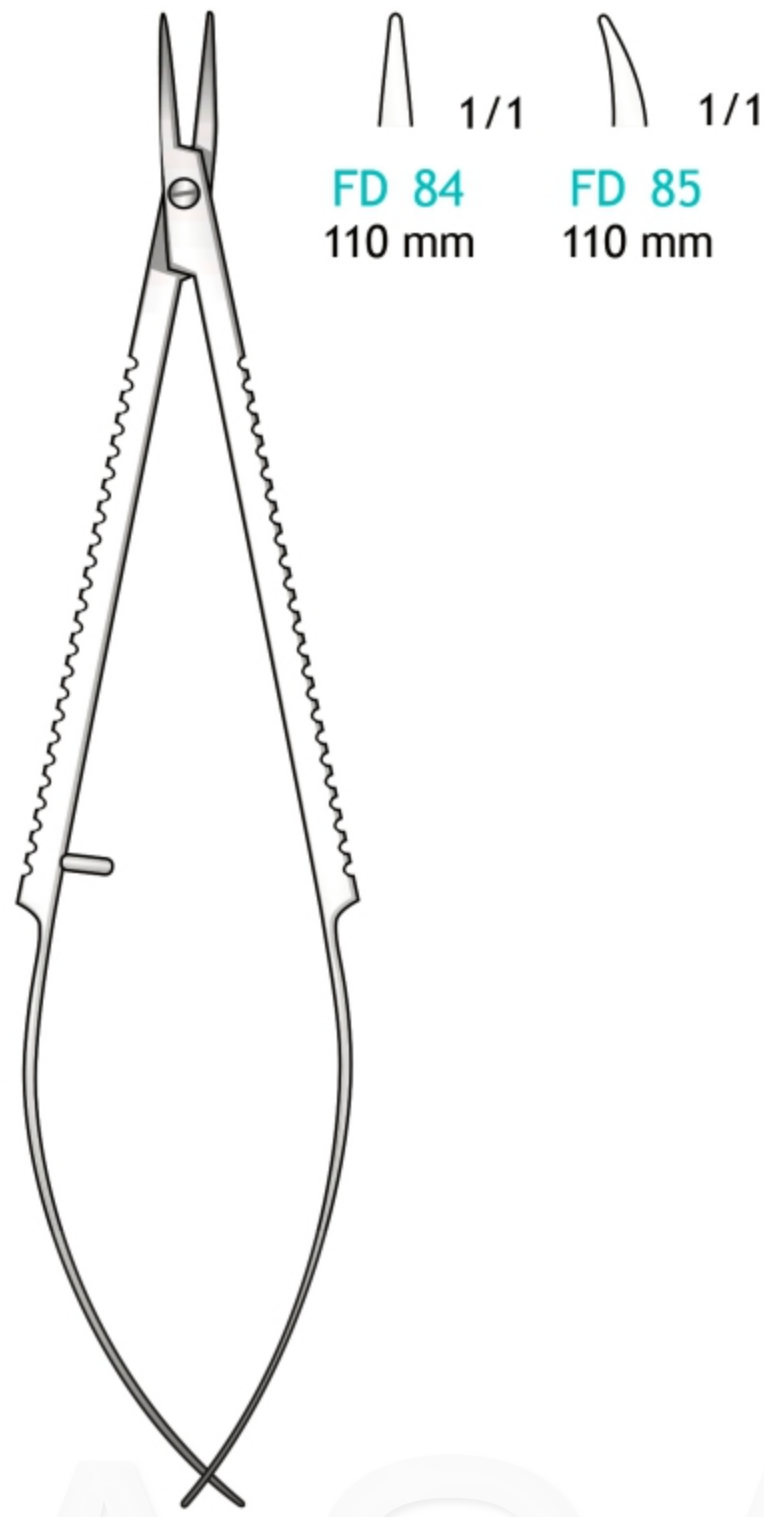

FD 84/FD 85  
110 mm

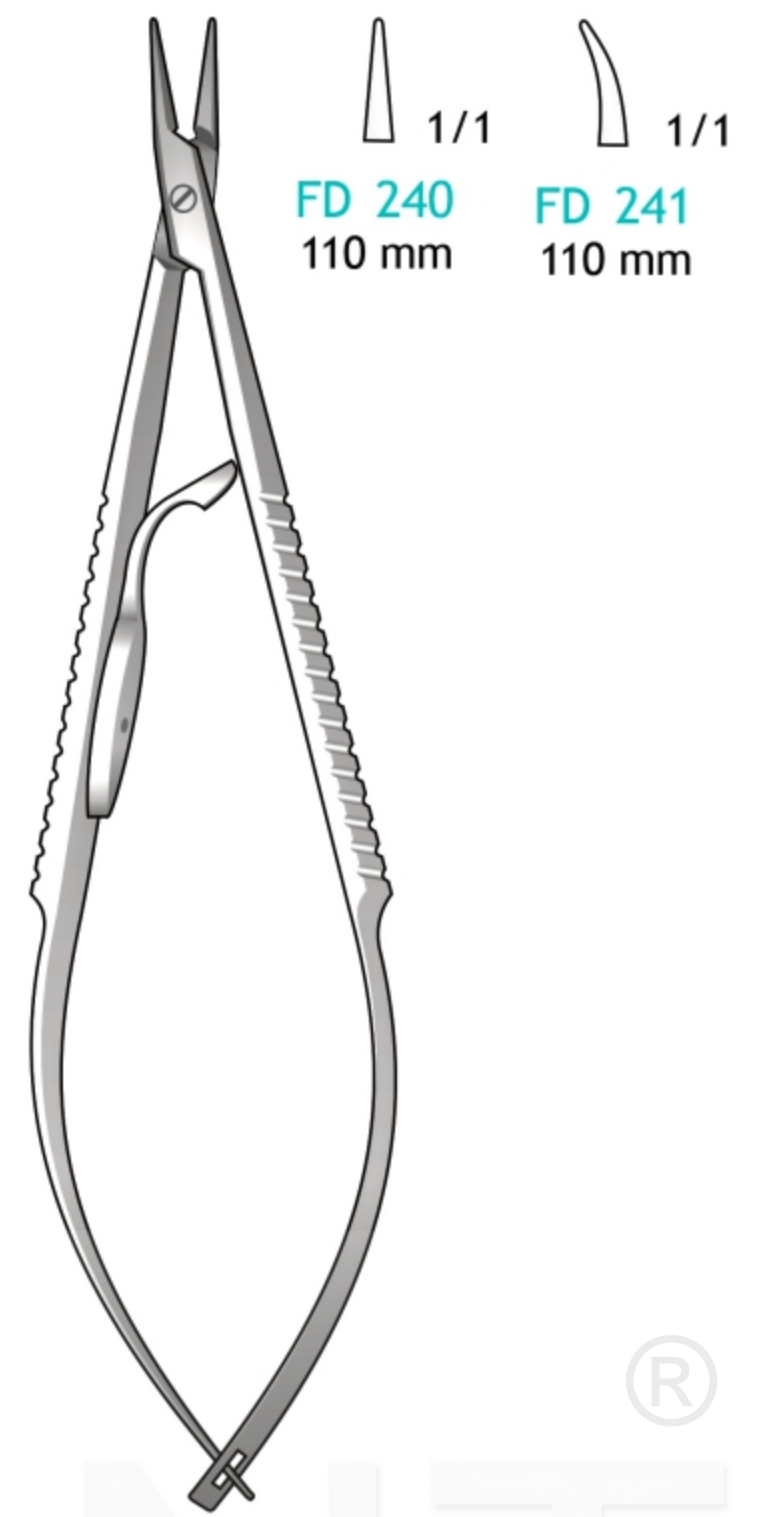

FD 240/FD 241  
110 mm

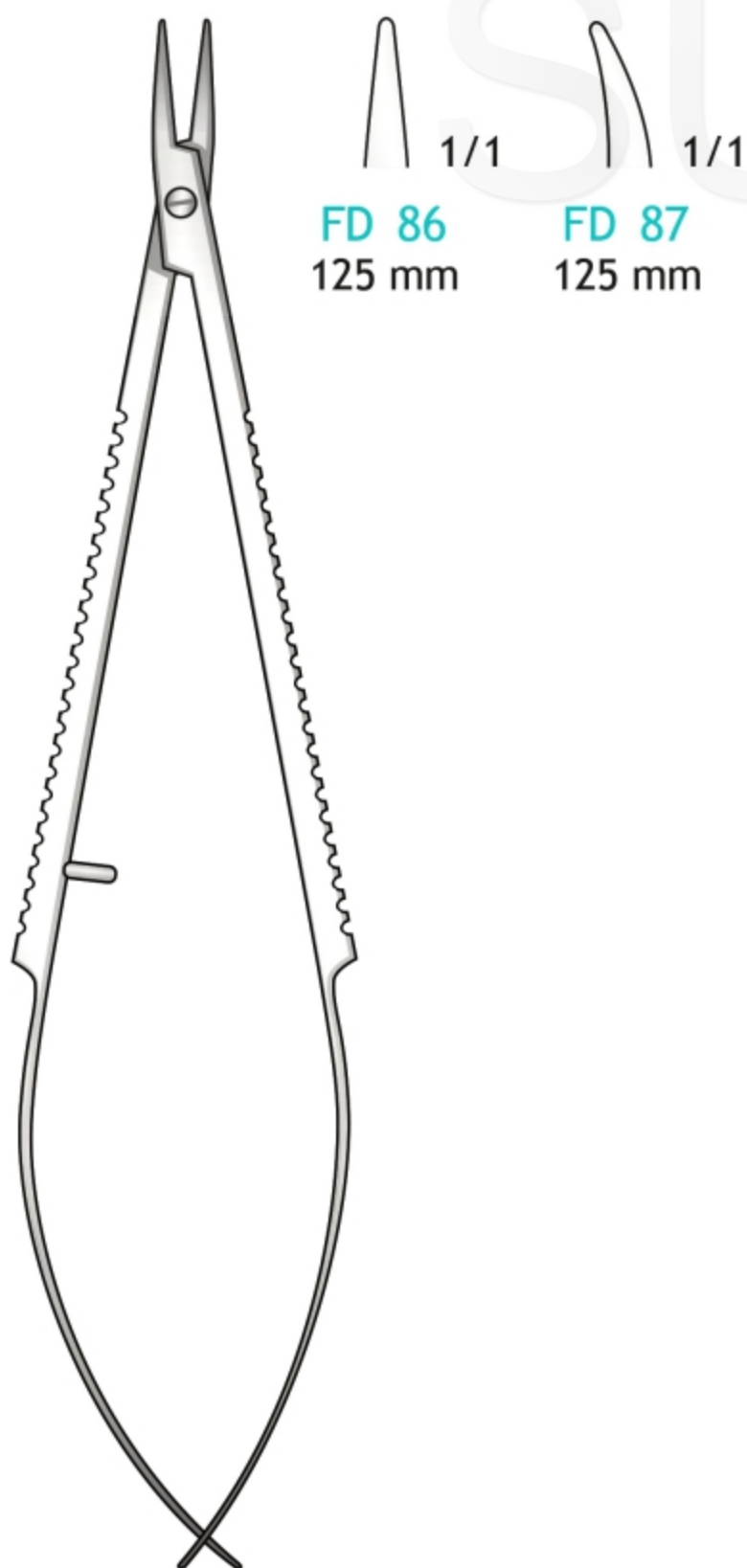

FD 86/FD 87  
125 mm

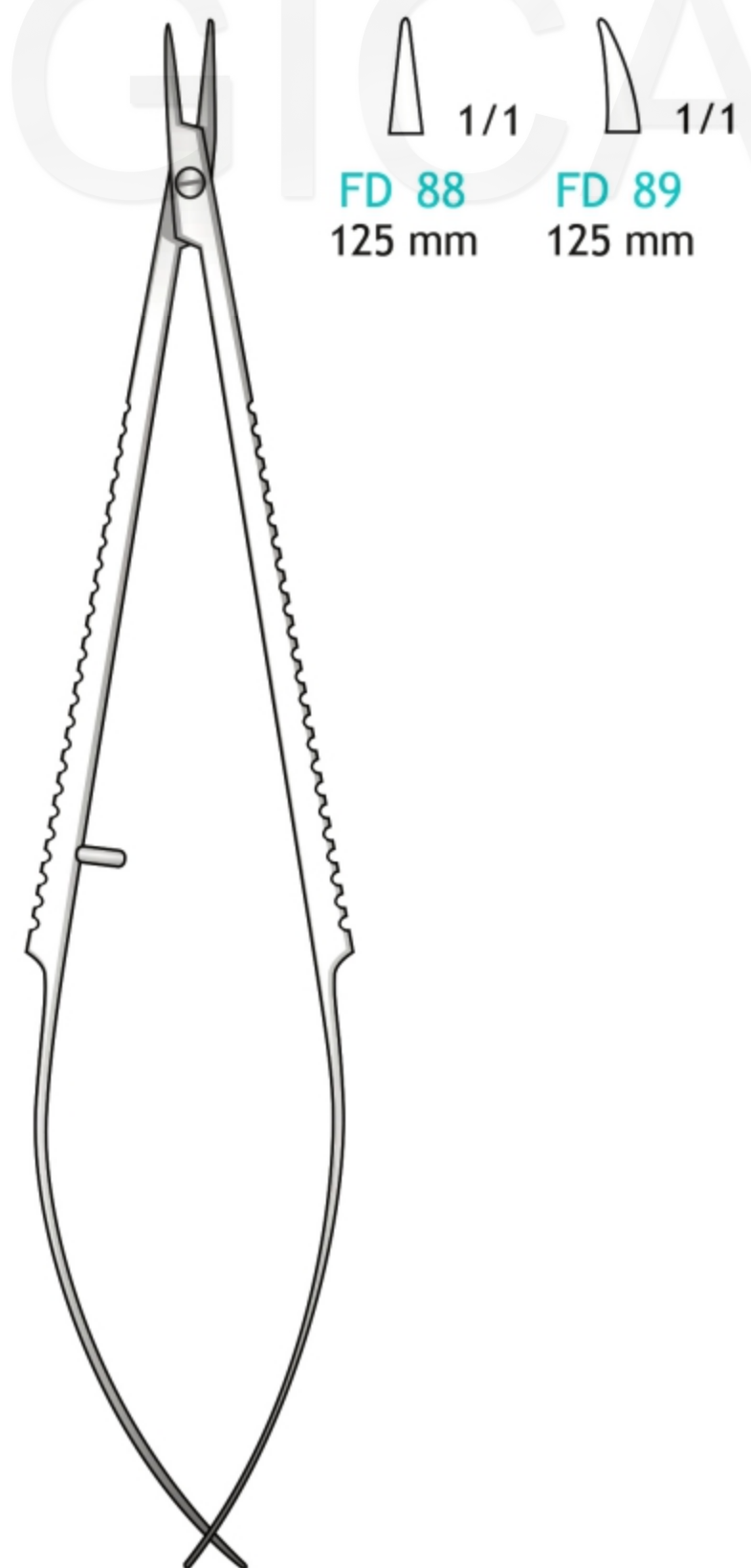

FD 88/FD 89  
125 mm

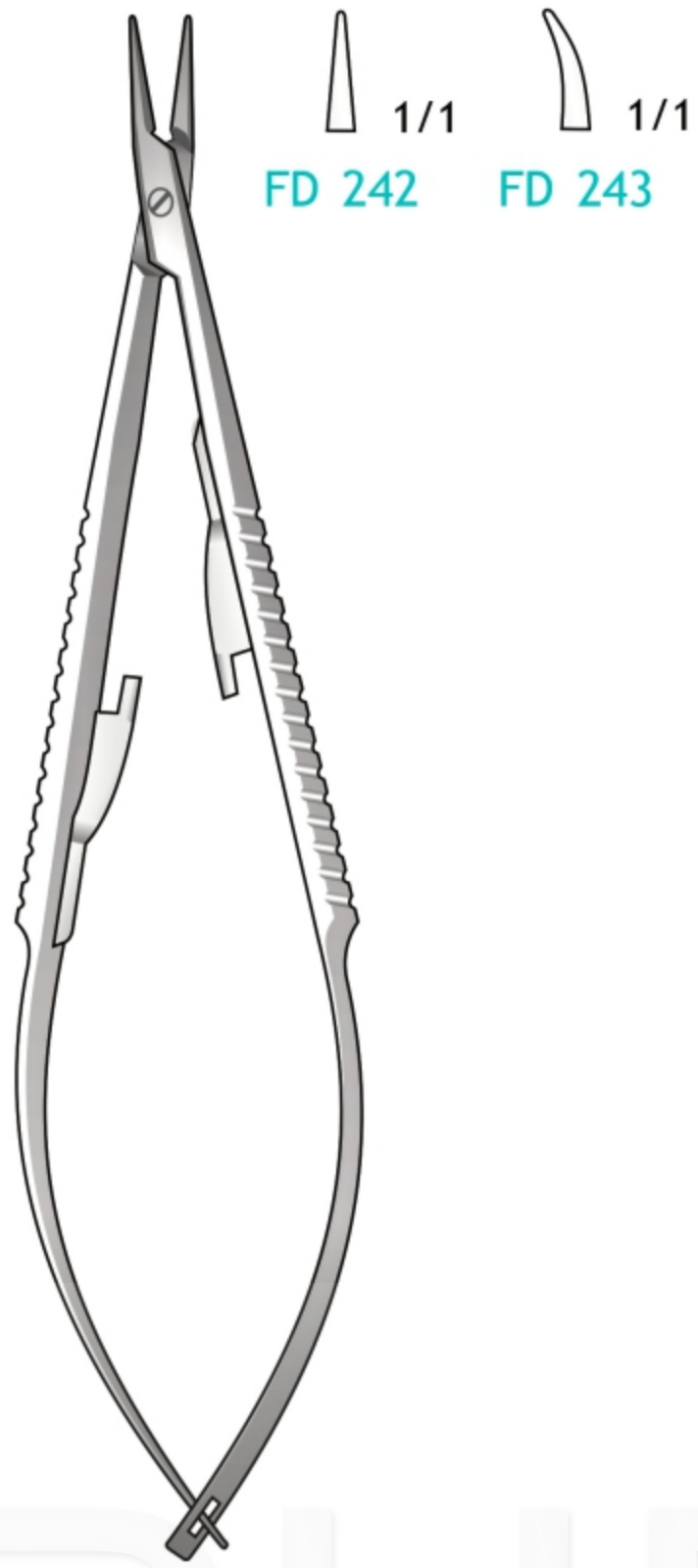

FD 242/FD 243  
125 mm

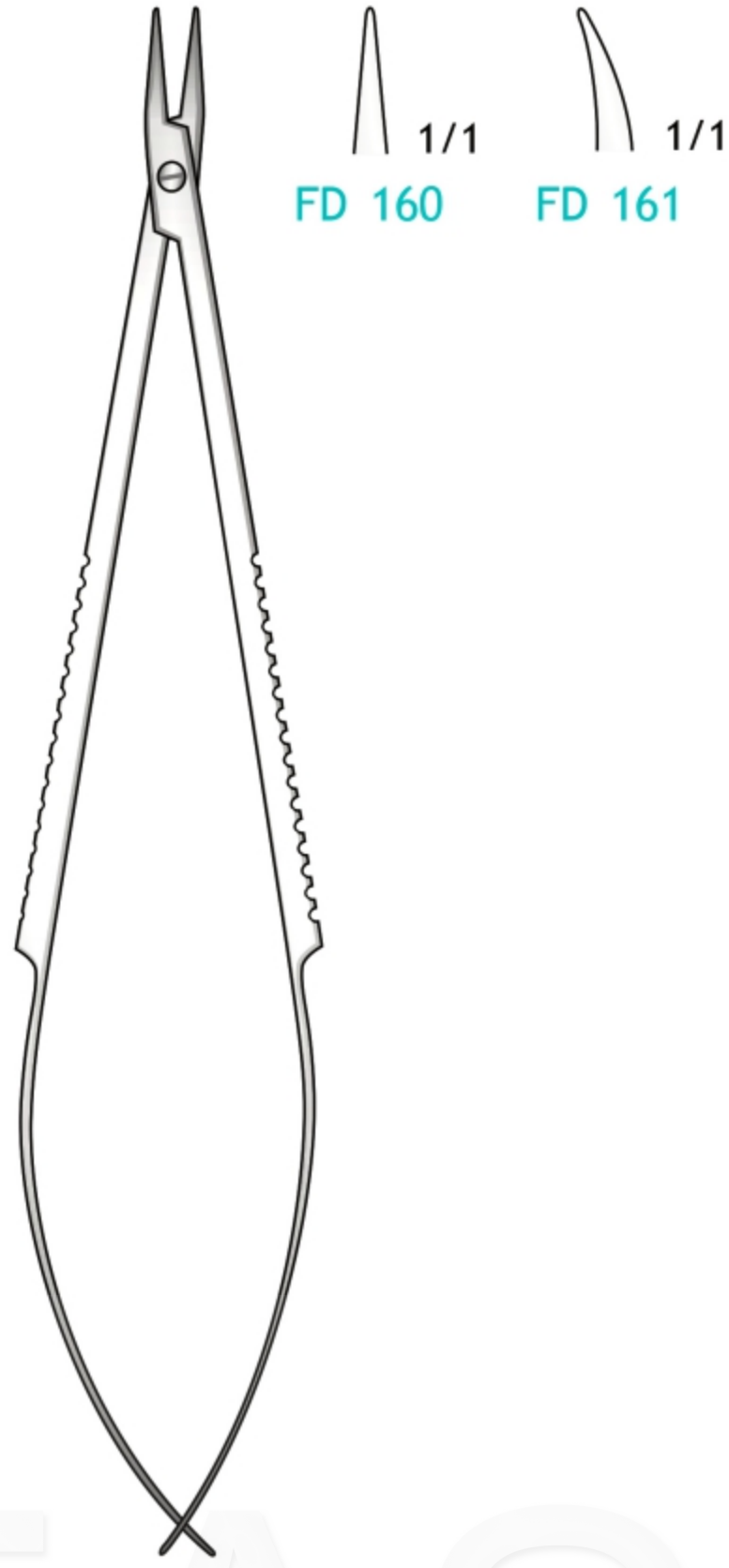

FD 160/FD 161  
135 mm

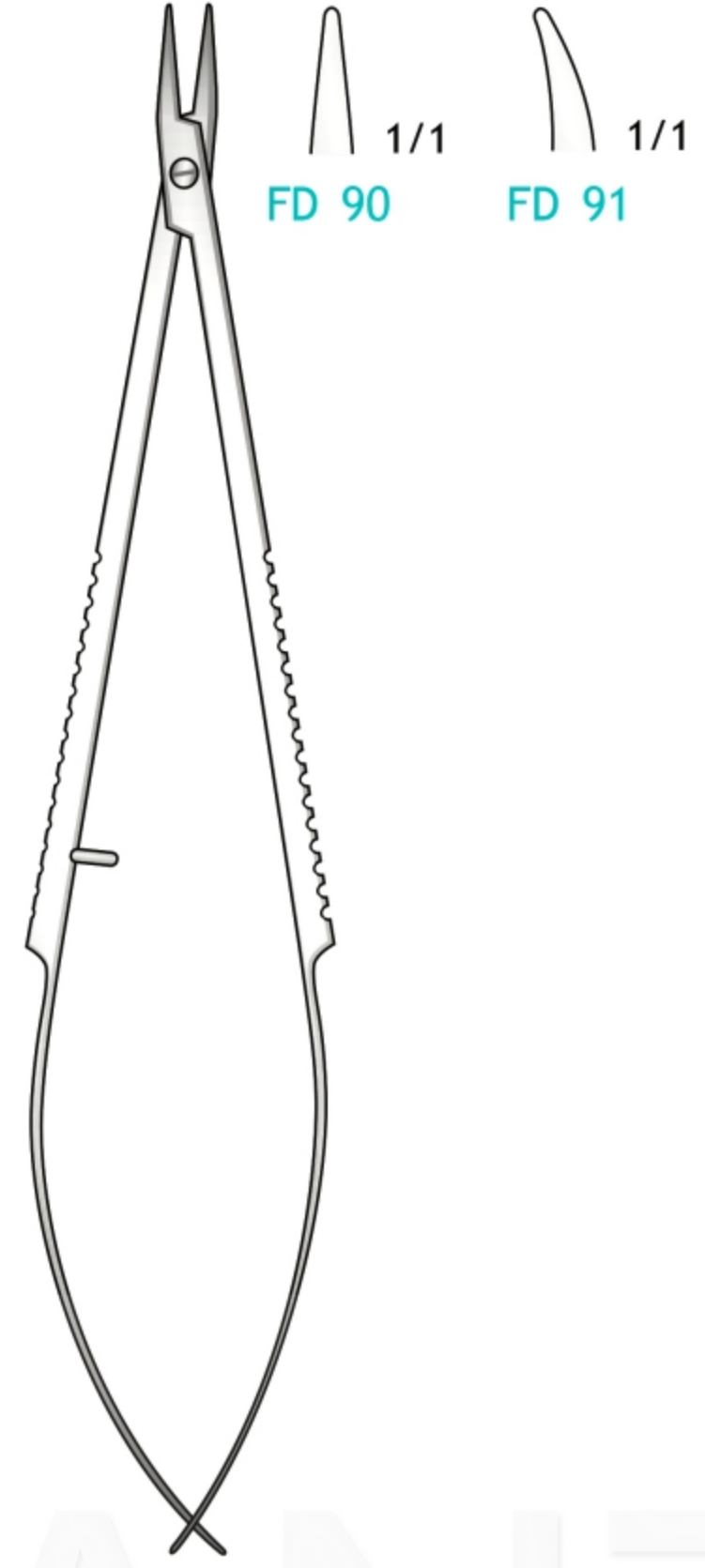

FD 90/FD 91  
135 mm

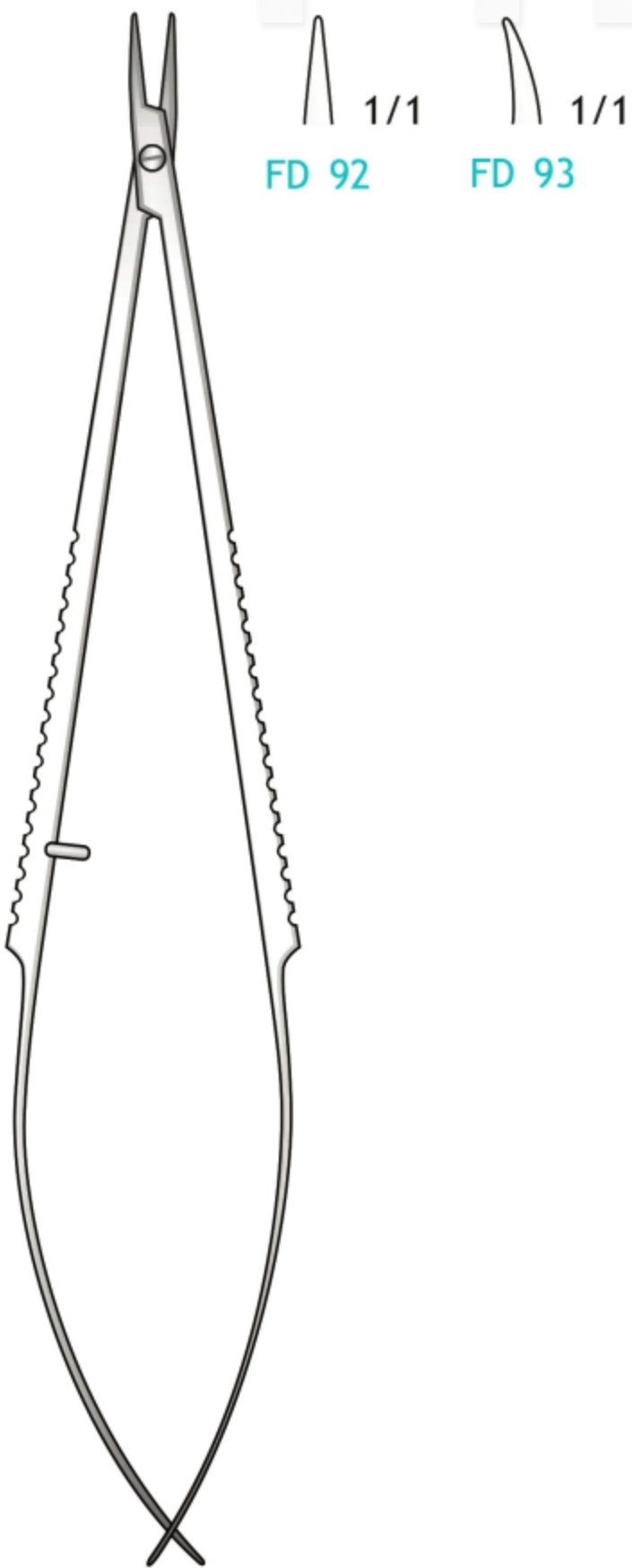

FD 92/FD 93  
135 mm

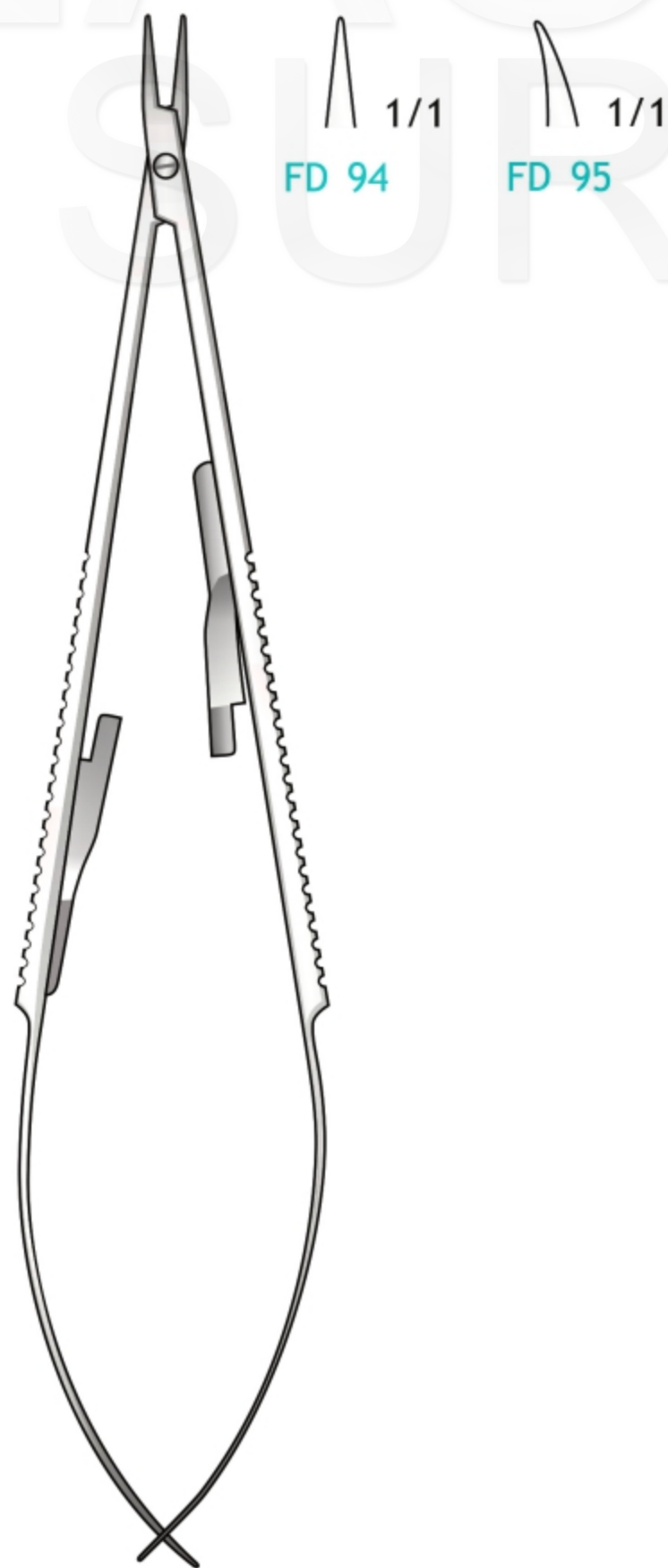

FD 94/FD 95  
135 mm

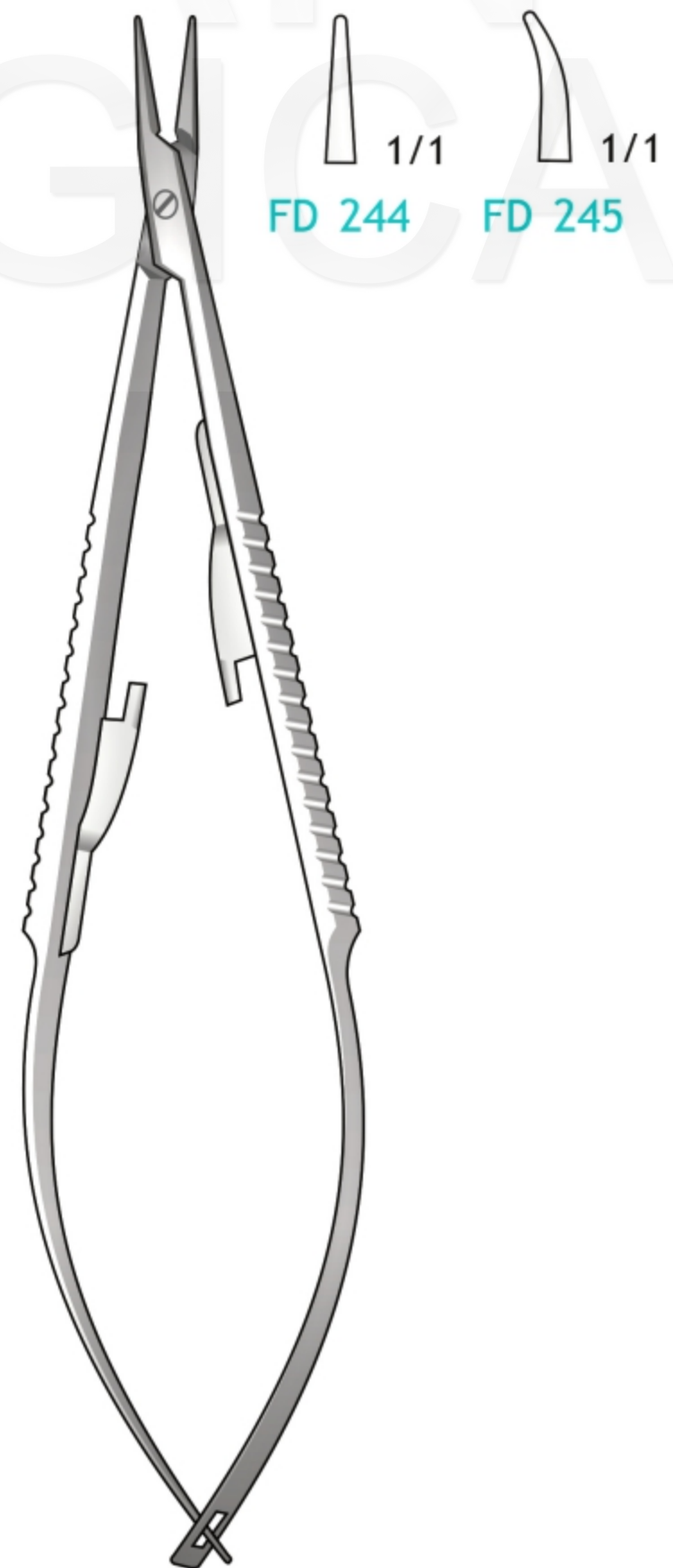

FD 244/FD 245  
135 mm

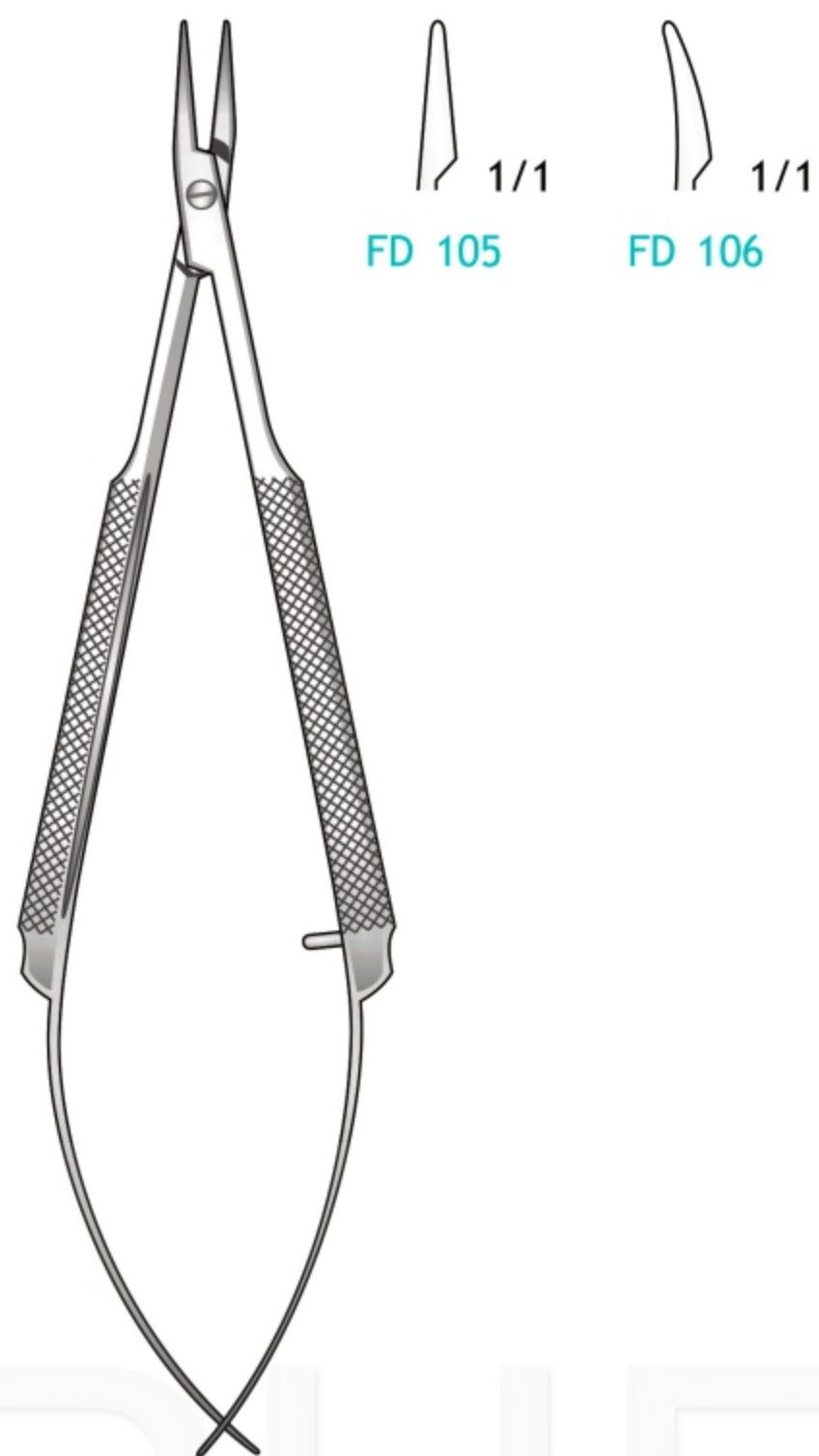

CASTROVIEJO  
FD 105/FD 106  
110 mm

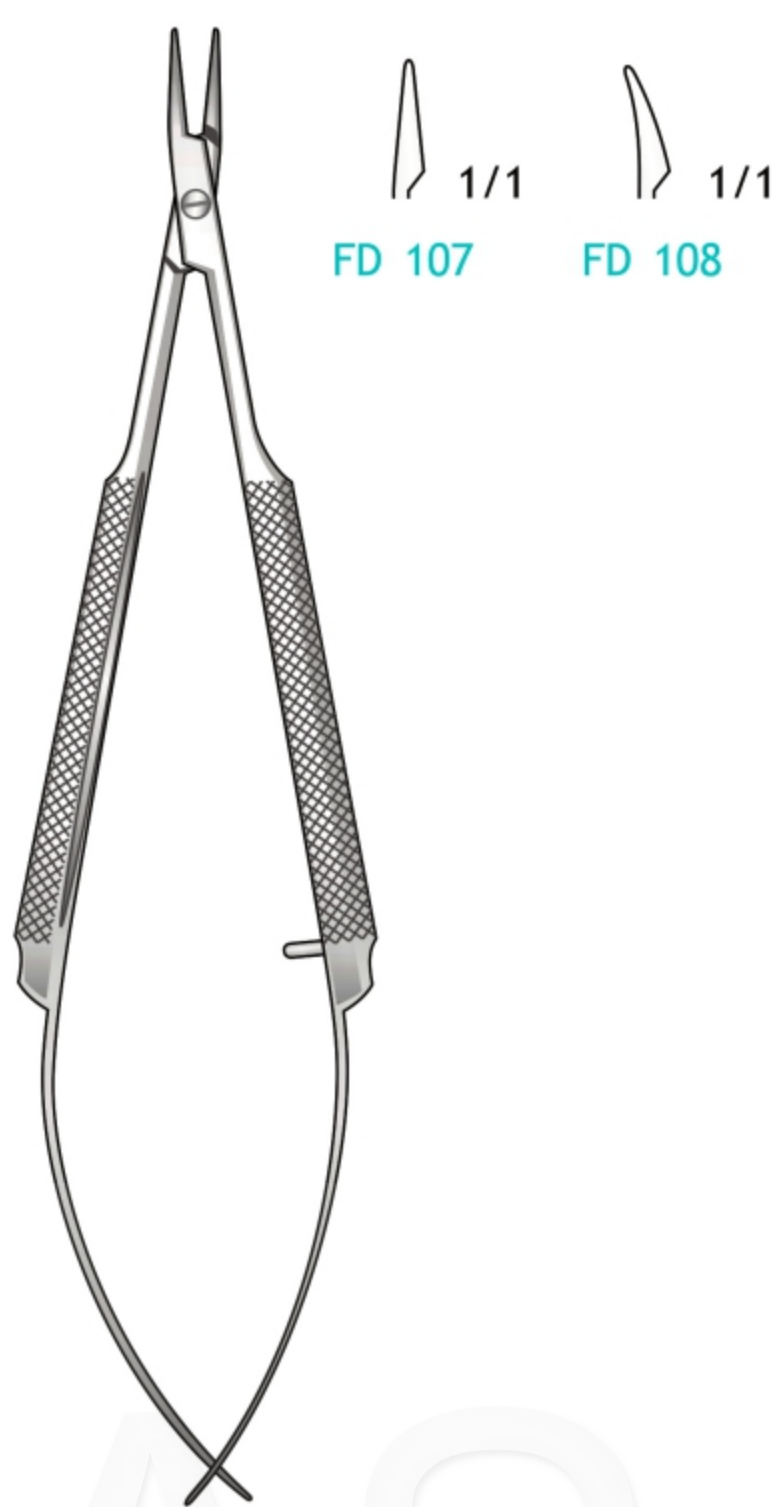

CASTROVIEJO  
FD 107/FD 108  
110 mm

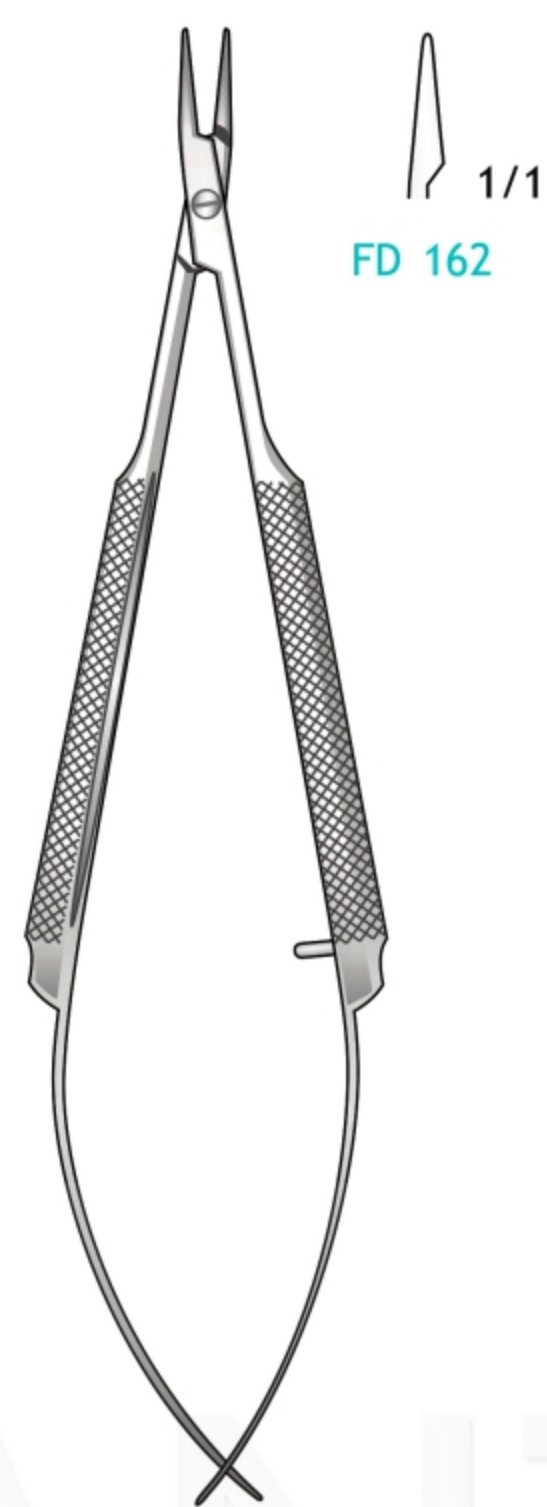

CASTROVIEJO  
FD 162  
110 mm

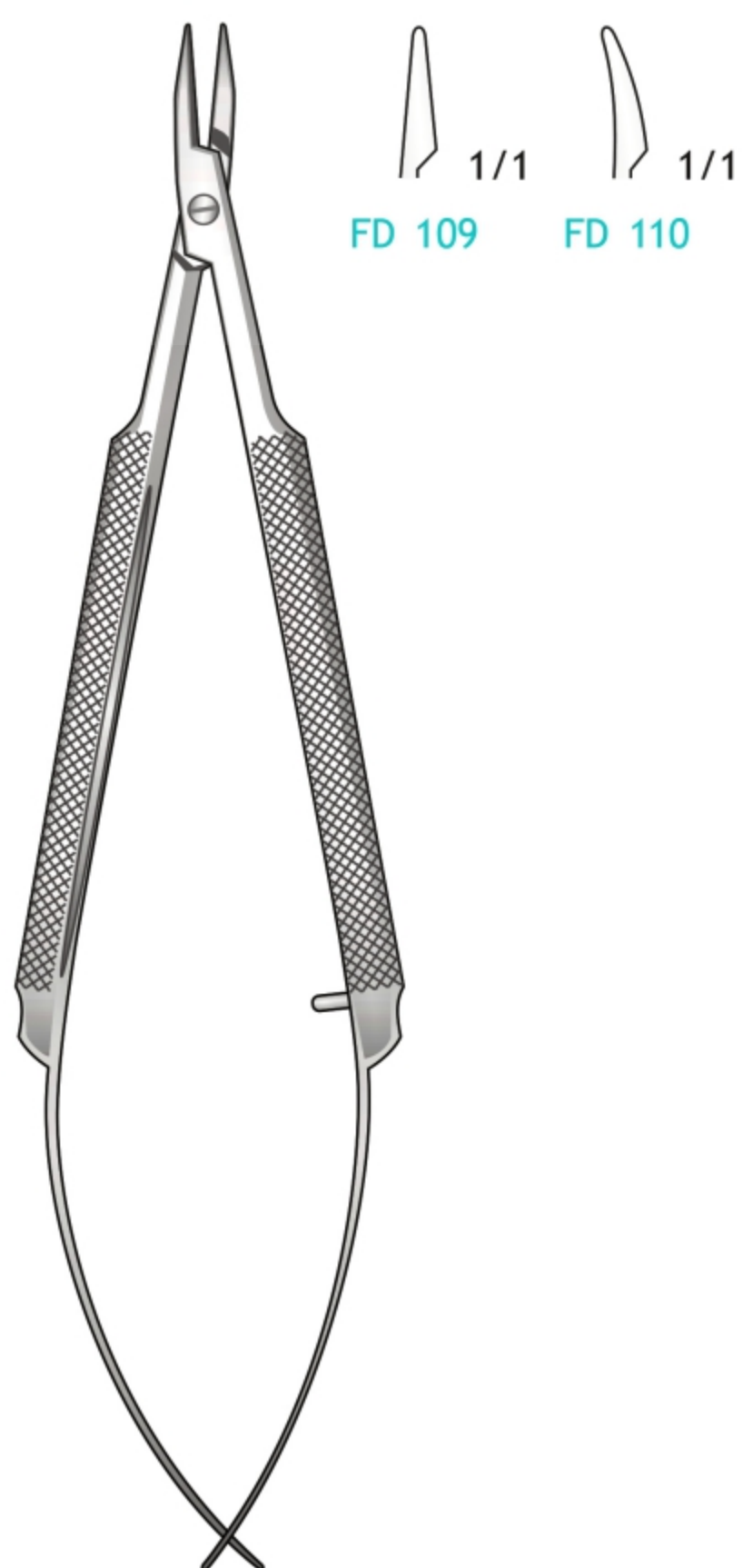

CASTROVIEJO  
FD 109/FD 110  
125 mm

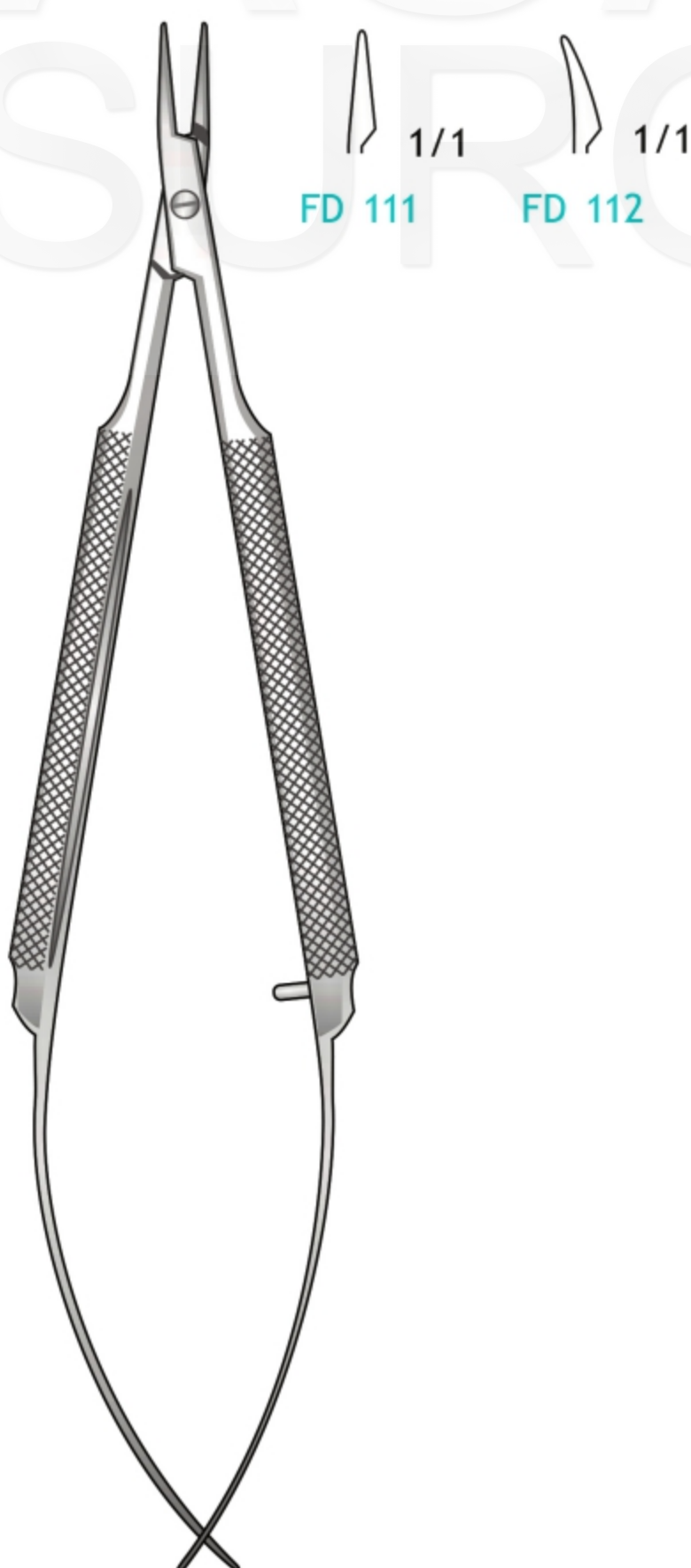

CASTROVIEJO  
FD 111/FD 112  
125 mm

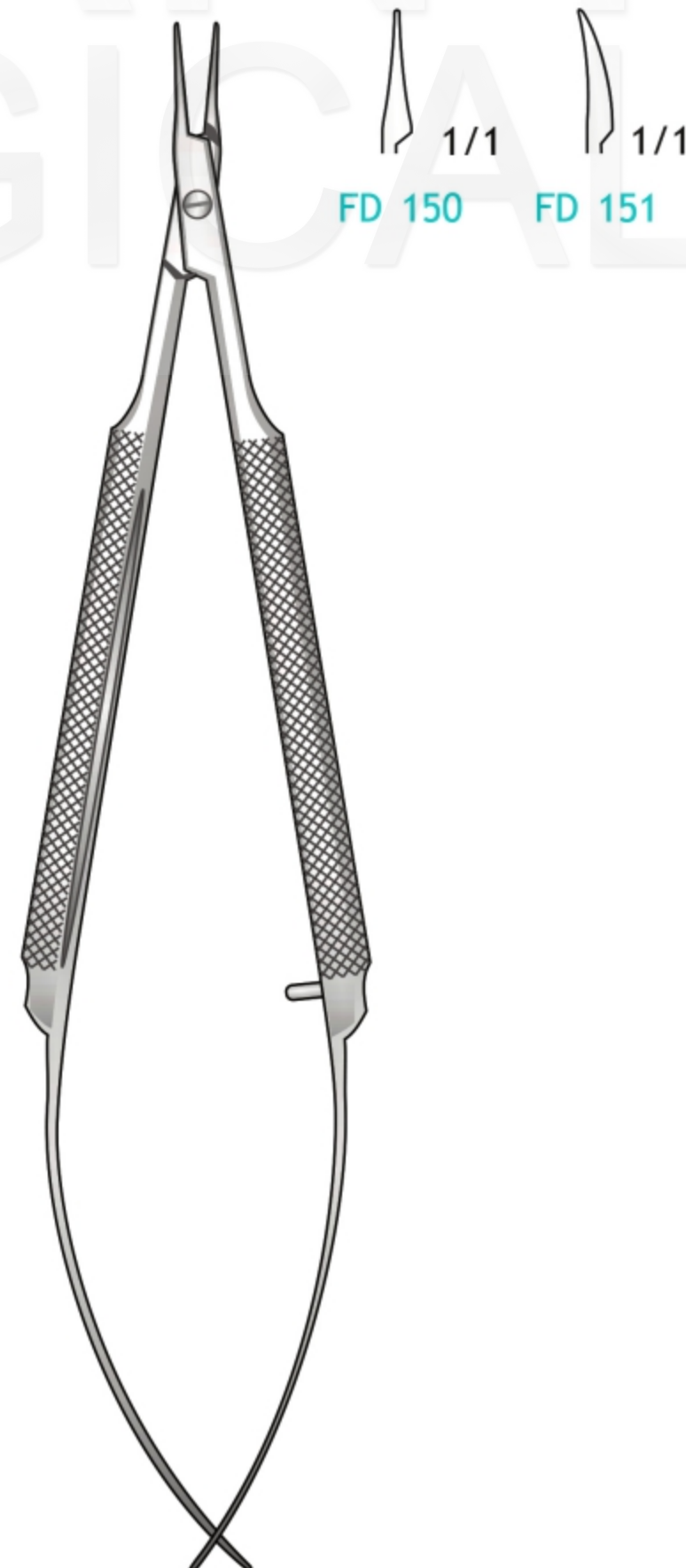

BARRAQUER  
FD 150/FD 151  
125 mm

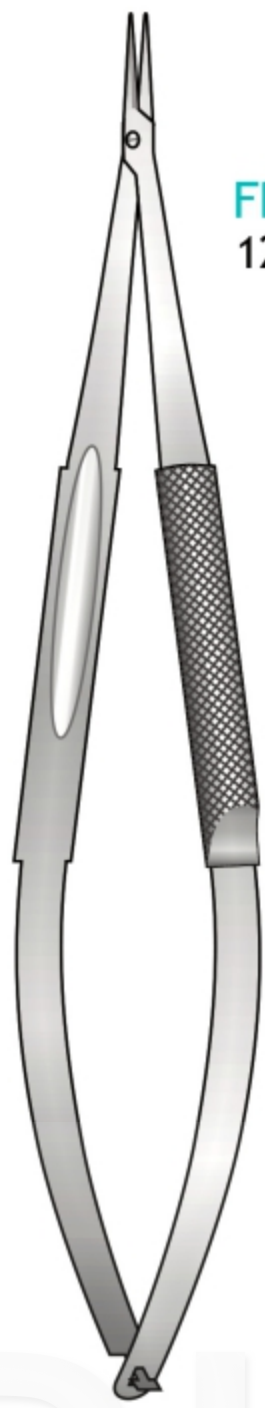

1/1  
FD 154  
125 mm



1/1  
FD 155  
125 mm

BARRAQUER  
FD 154/FD 155  
125 mm

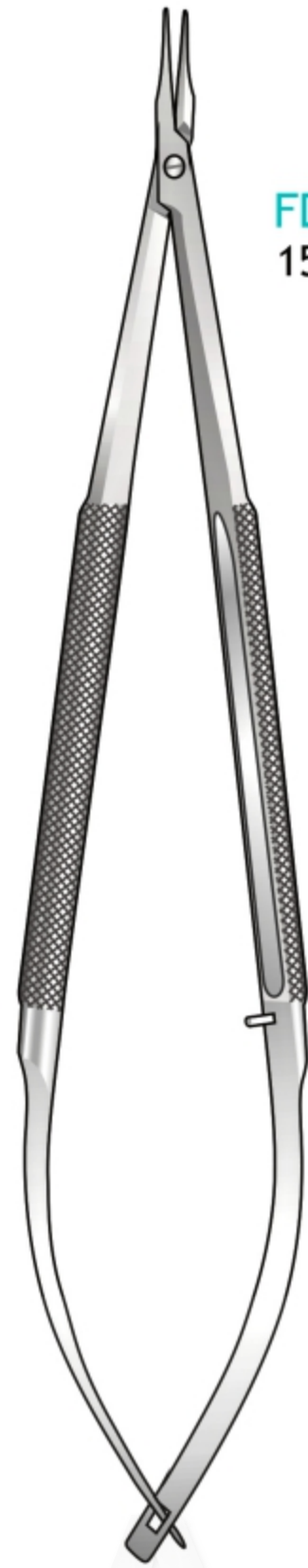

1/1  
FD 152  
150 mm



1/1  
FD 153  
150 mm

BARRAQUER  
FD 152/FD 153  
150 mm

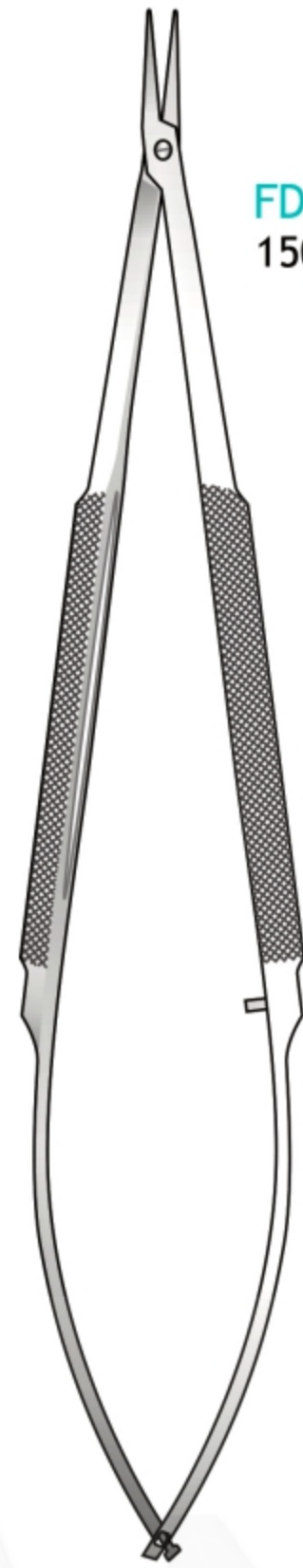

1/1  
FD 156  
150 mm



1/1  
FD 157  
150 mm

REILL  
FD 156/FD 157  
150 mm

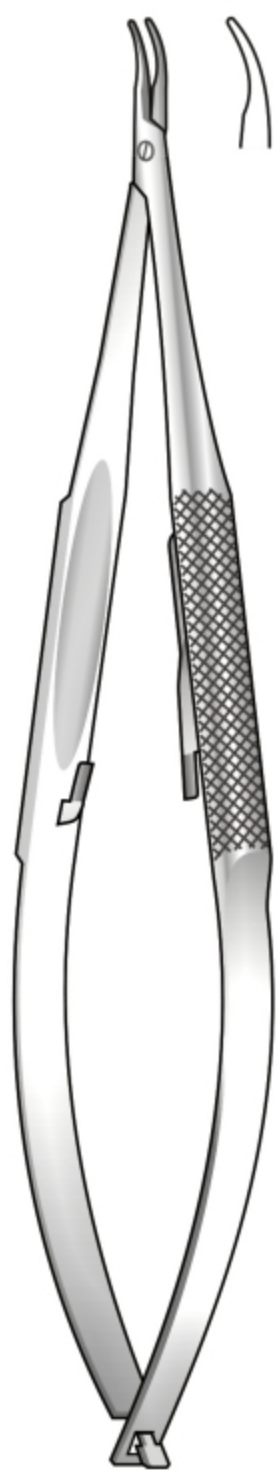

1/1  
BARRAQUER  
FD 215  
120 mm

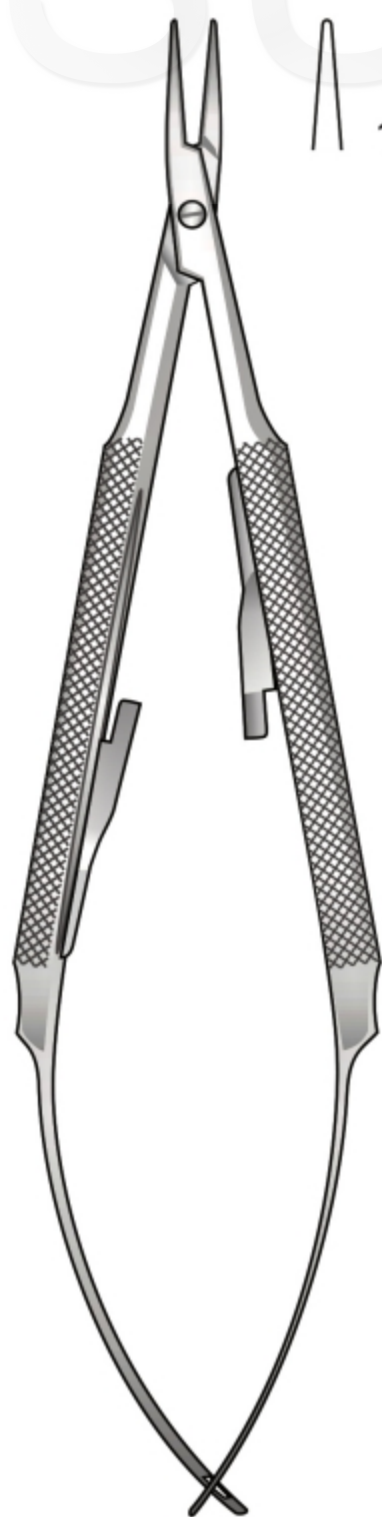

1/1  
BARRAQUER  
FD 214  
125 mm

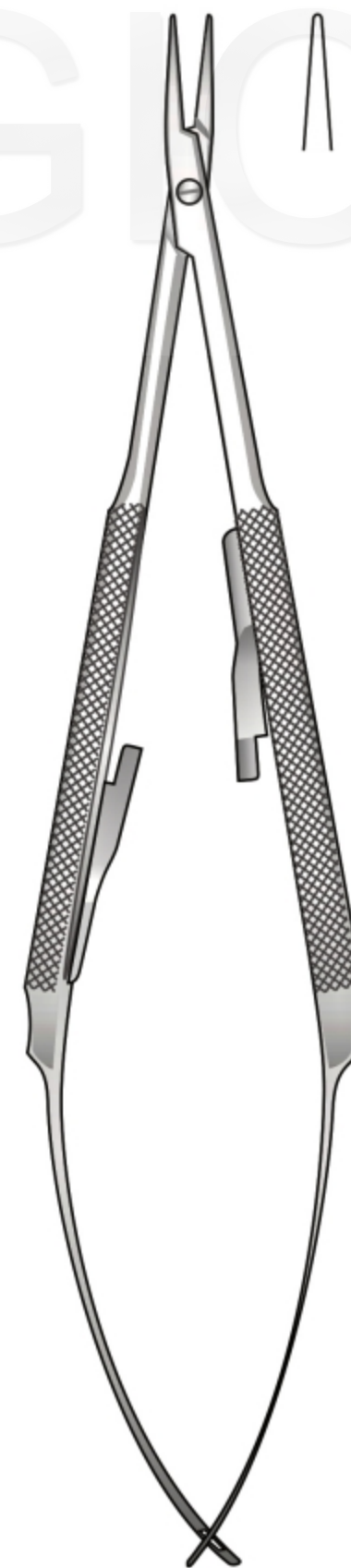

1/1  
BARRAQUER  
FD 216  
150 mm



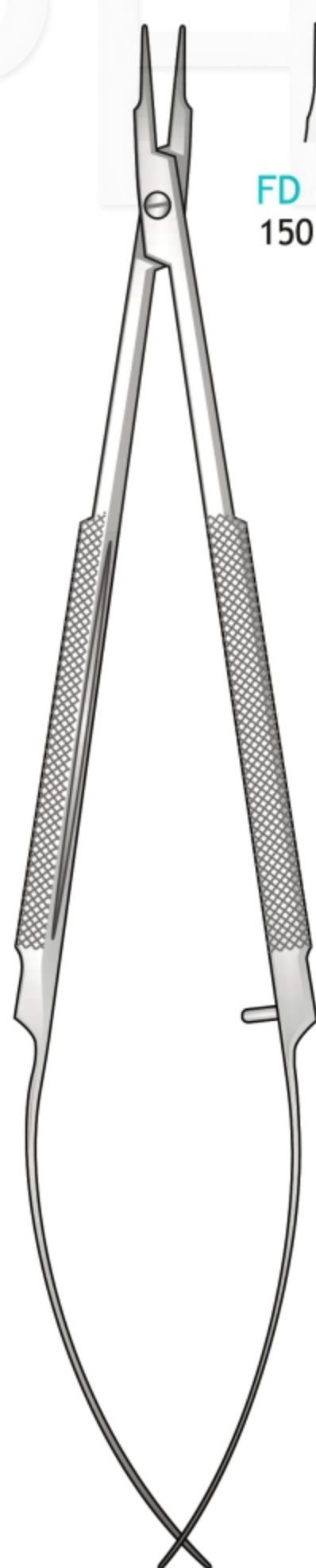

FD 121  
150 mm

FD 122  
150 mm

BARRAQUER  
FD 121/FD 122  
150 mm

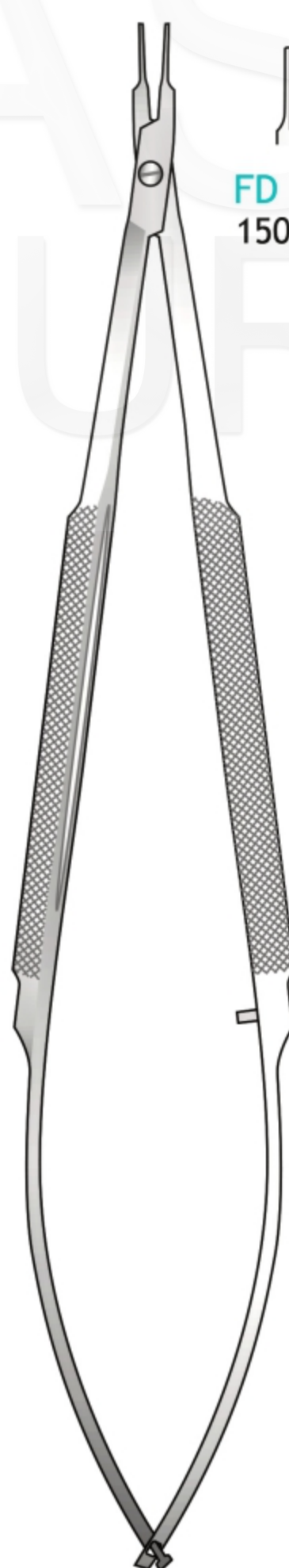

FD 165  
150 mm

FD 166  
150 mm

BARRAQUER  
FD 165/FD 166  
150 mm

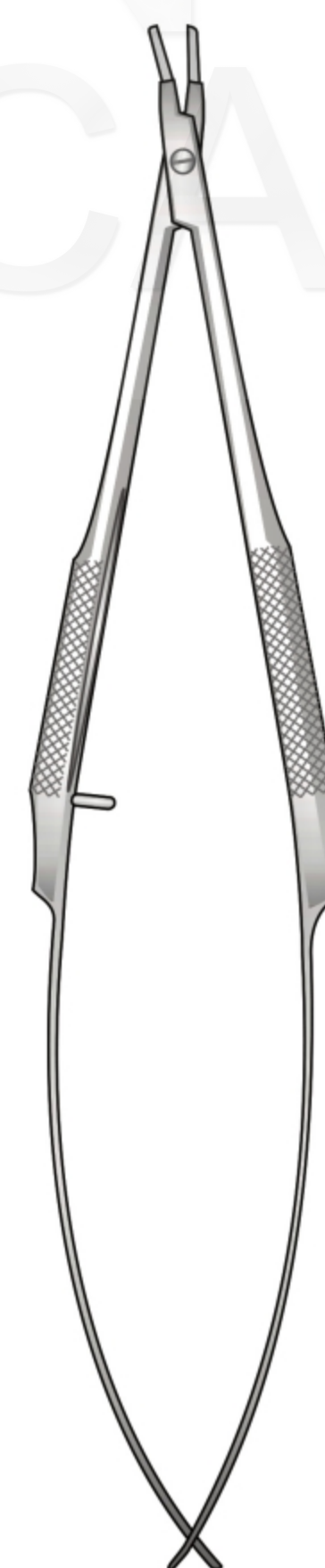

FD 169  
135 mm

BARRAQUER  
FD 169  
135 mm

Micro forceps  
Micro pinzette  
Mikro Pinzetten  
Micro pincers  
Pinzas finos

1 x 2 Teeth  
1 x 2 Denti  
1 x 2 Zähne  
1 x 2 Dents  
1 x 2 Dientes

1 x 2 Teeth  
1 x 2 Denti  
1 x 2 Zähne  
1 x 2 Dents  
1 x 2 Dientes

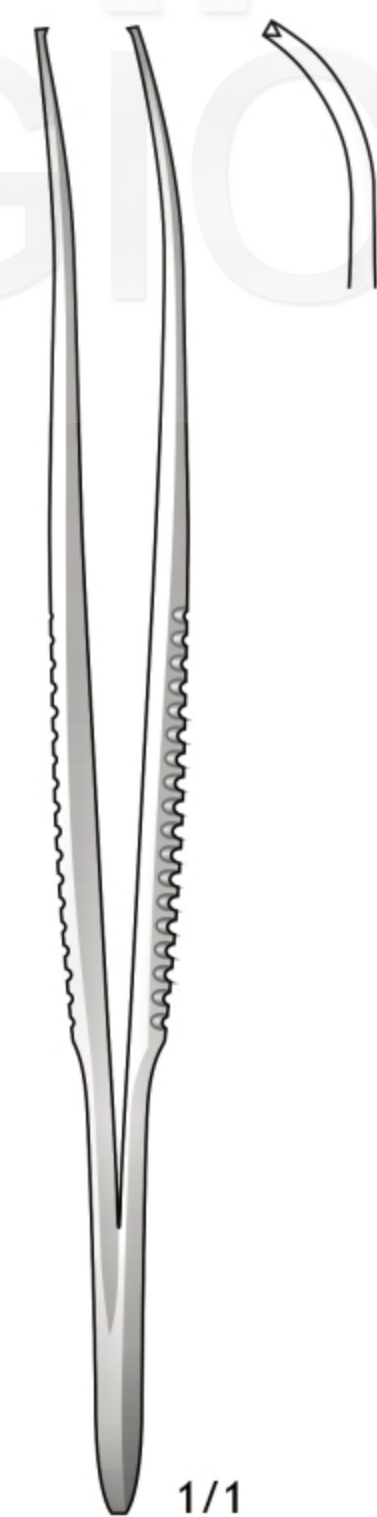
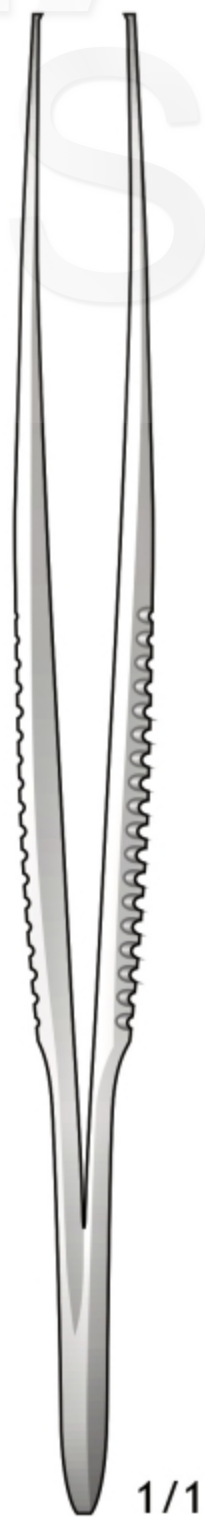
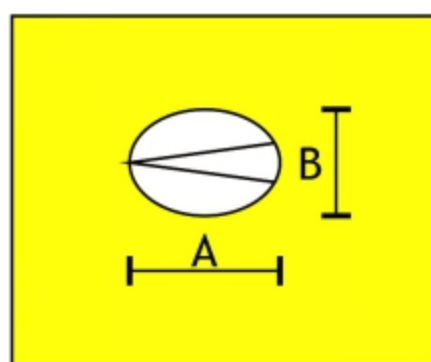

A	B		
0,4	0,25	MF 34	MF 40
0,5	0,35	MF 35	MF 41
0,7	0,55	MF 36	MF 42
1	0,8	MF 37	MF 43
1,2	0,9	MF 38	MF 44
		95 mm	95 mm

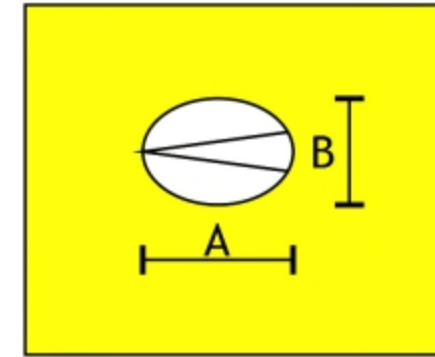

Micro forceps  
Micro pinzette  
Mikro Pinzetten  
Micro pincers  
Pinzas finos

1 x 2 Teeth  
1 x 2 Denti  
1 x 2 Zähne  
1 x 2 Dents  
1 x 2 Dientes

1 x 2 Teeth  
1 x 2 Denti  
1 x 2 Zähne  
1 x 2 Dents  
1 x 2 Dientes

Sharp  
Acuta  
Spitz  
Pointu  
Agudas

Blunt  
Smussa  
Stumpf  
Mousse  
Romas

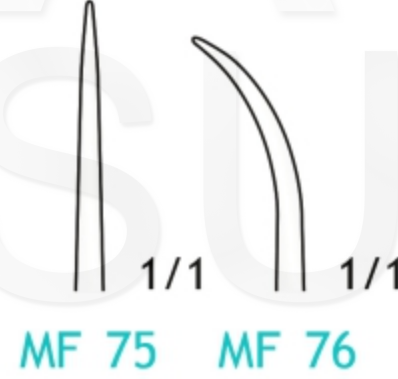
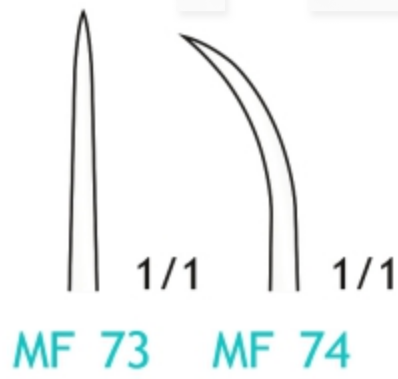

MF 73/MF 74  
95 mm

MF 75/MF 76  
95 mm

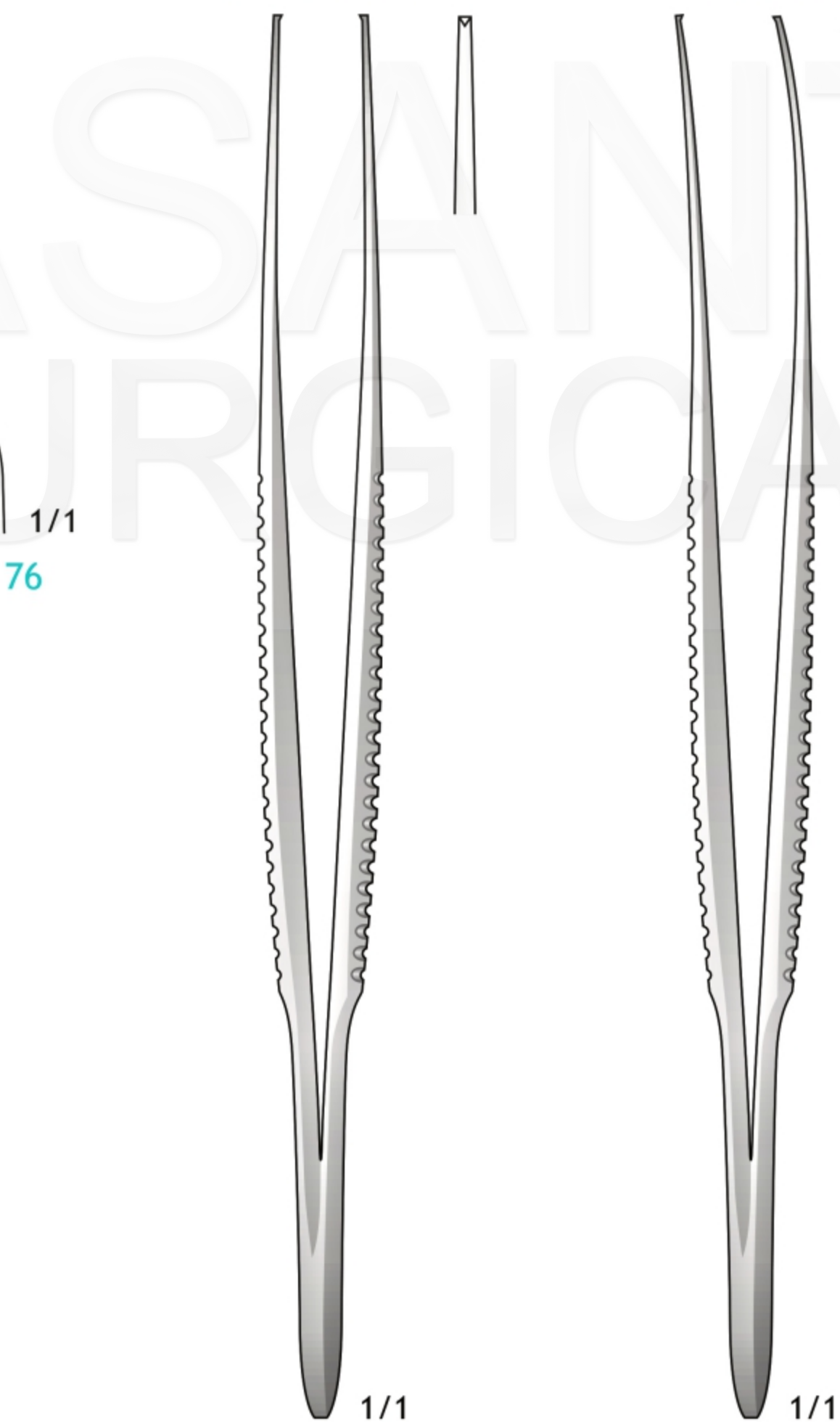

A	B		
0,4	0,25	MF 46	MF 52
0,5	0,35	MF 47	MF 53
0,7	0,55	MF 48	MF 54
1	0,8	MF 49	MF 55
1,2	0,9	MF 50	MF 56
		125 mm	125 mm

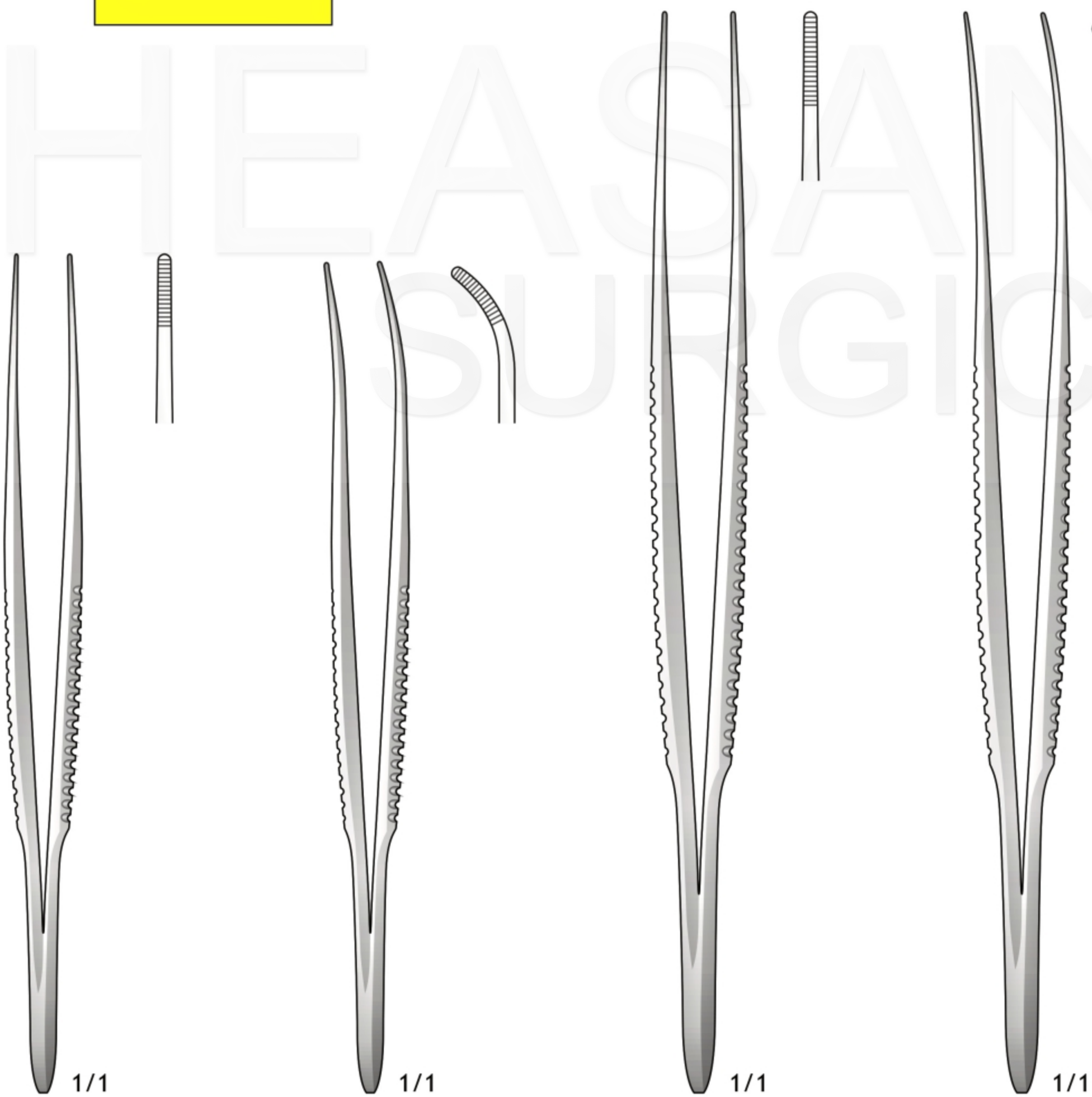
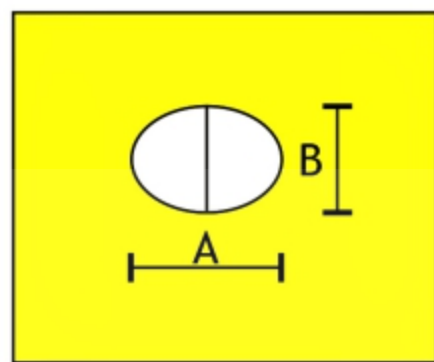

A	B				
0,5	0,4	MF 24	MF 29	MF 19	MF 13
0,6	0,5	MF 25	MF 30	MF 20	MF 14
0,9	0,7	MF 26	MF 31	MF 21	MF 15
1,3	1	MF 27	MF 32	MF 22	MF 16
1,6	1,3	MF 28	MF 33	MF 23	MF 17
		95 mm	95 mm	125 mm	125 mm

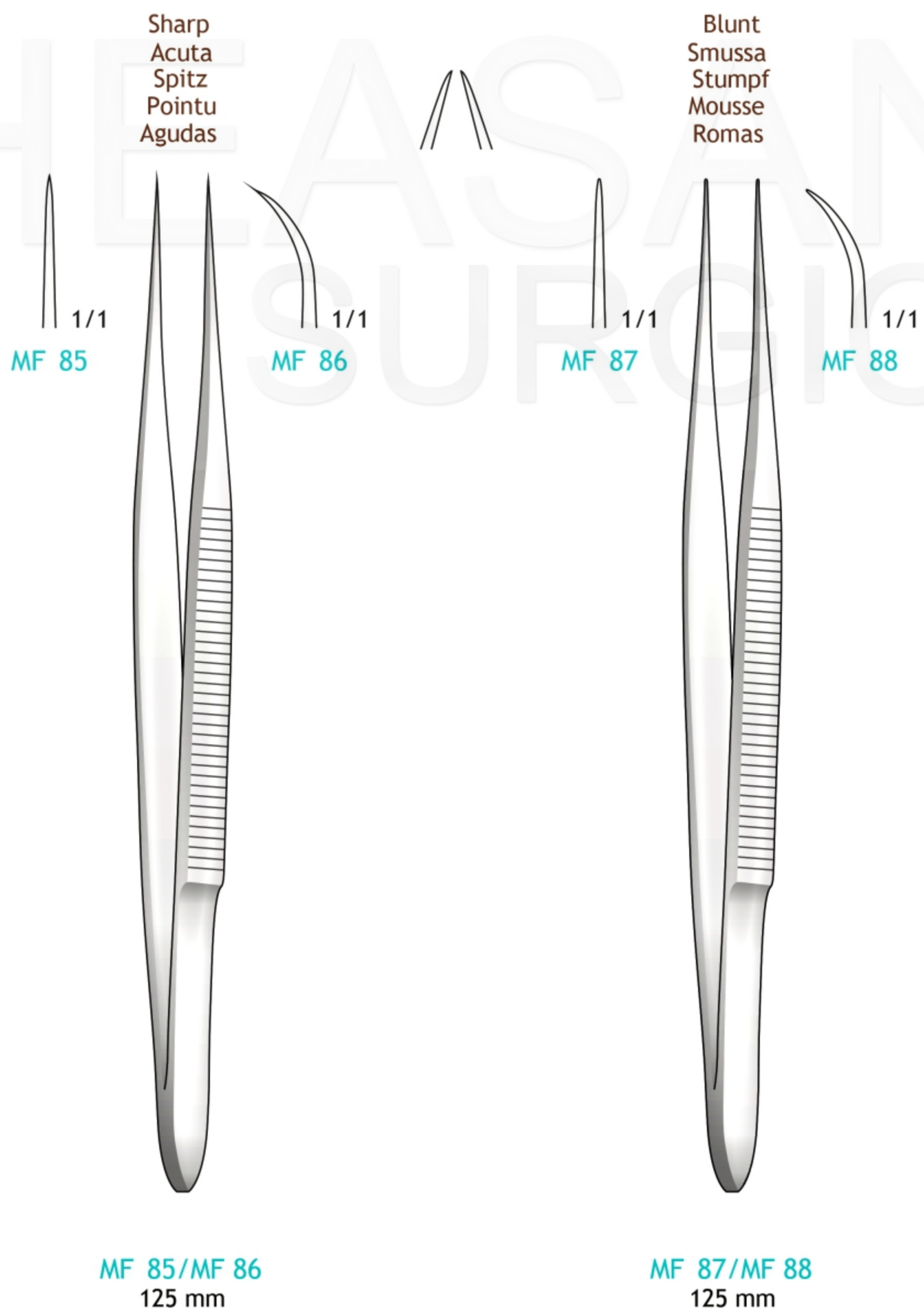

Sharp  
Acuta  
Spitz  
Pointu  
Agudas

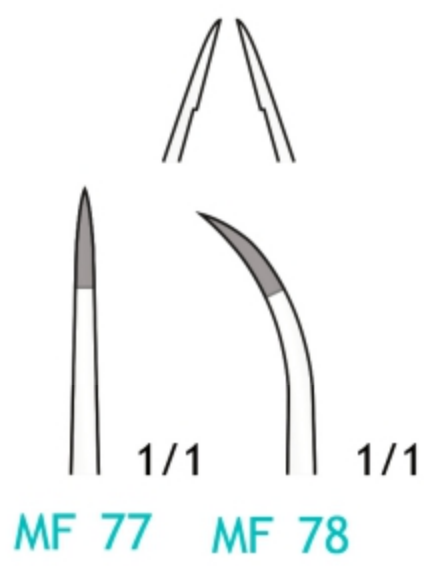
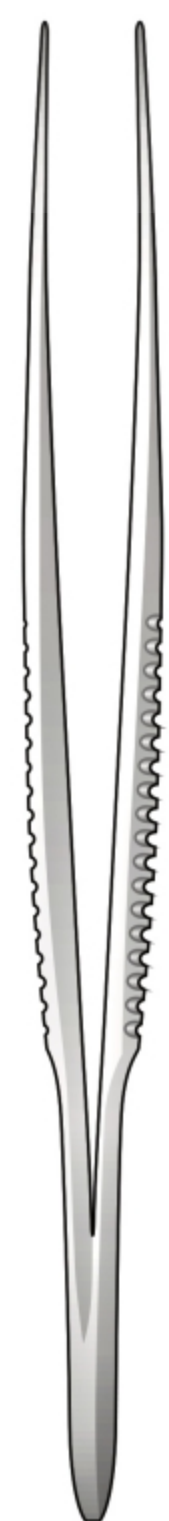

MF 77/MF 78  
95 mm

Blunt  
Smussa  
Stumpf  
Mousse  
Romos

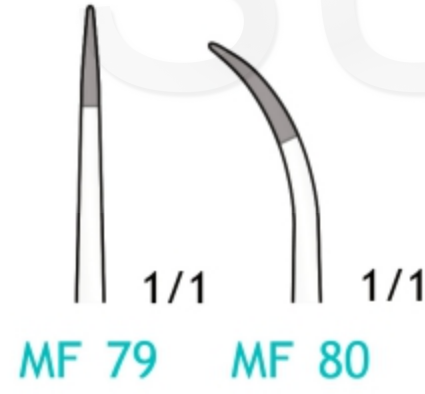

MF 79/MF 80  
95 mm

Sharp  
Acuta  
Spitz  
Pointu  
Agudas

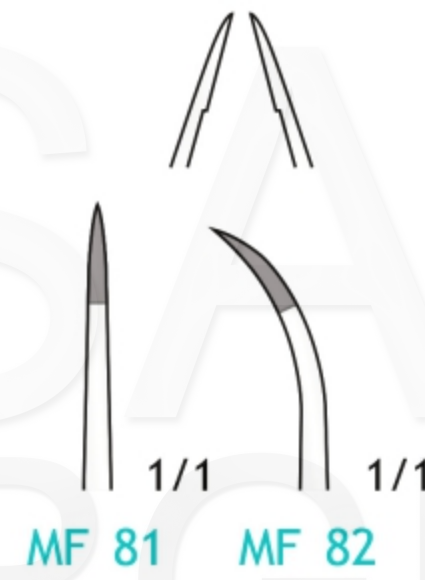
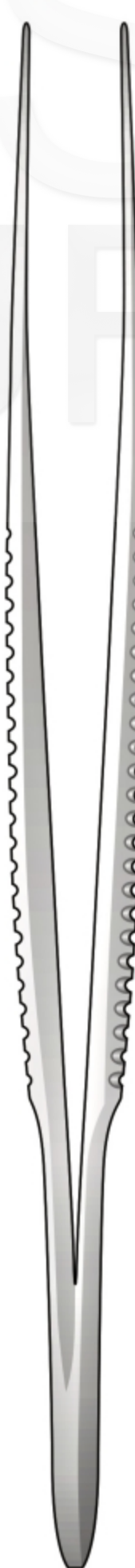

MF 81/MF 82  
125 mm

Blunt  
Smussa  
Stumpf  
Mousse  
Romos

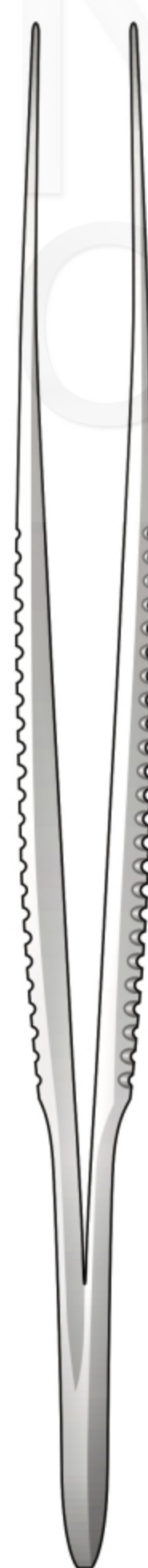

MF 83/MF 84  
125 mm

Ophthalmic Microsurgery set

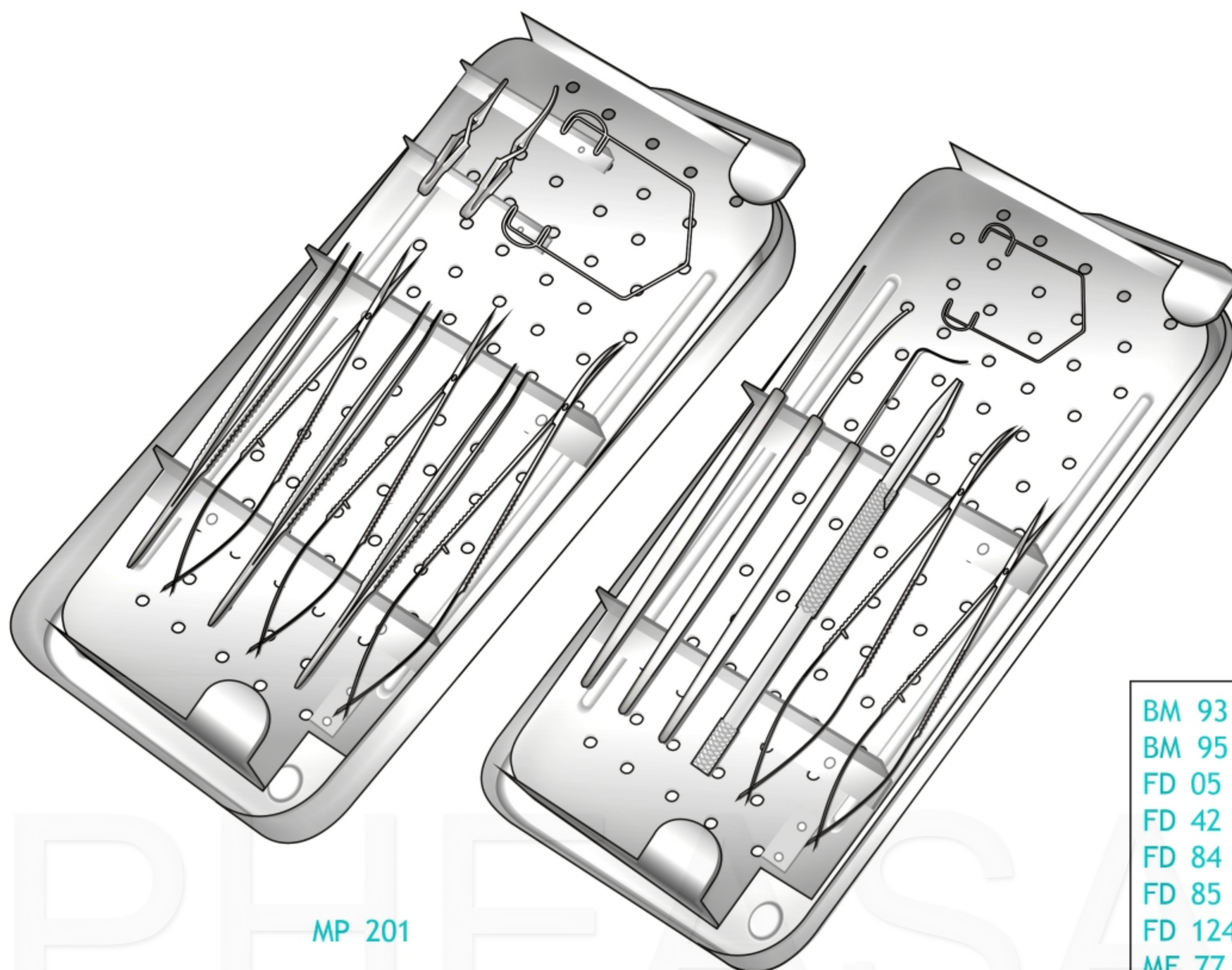

MP 201

**MP 201**  
Consisting

- BM 93 - Bulldog straight cm. 4
- BM 95 - Bulldog straight cm. 4,5
- FD 05 - Micro scissors cur cm. 11
- FD 42 - Micro scissors cur cm. 12
- FD 84 - Micro forceps str cm. 11
- FD 85 - Micro forceps cur cm. 11
- FD 124 - Micro forceps 1x2 teeth cm. 11
- MF 77 - Micro forceps str cm. 9,5
- MF 79 - Micro forceps str cm. 9,5
- NK 12 - Port micro blades cm. 12
- NK 18 - Micro scalpal Graefe cm. 13
- NK 23 - Micro divar. Castrovejo cm. 13
- NK 28 - Micro spatulas Wecker cm. 13
- NK 60 - Micro forceps Colibri cm. 8
- NK 80 - Blefarostato Barraquer mm. 27x5



MP 210

**MP 210**  
Consisting

- BT 16 - Micro retractor. Gillies # 2
- DB 21 - Curette Day cm. 16
- FD 54 - Micro scissors curved cm. 16
- FD 135 - Micro scissors straight cm. 16
- FD 158 - Micro needle holder str. cm. 15
- FD 159 - Micro needle holder cur cm. 15
- MF 58 - Micro forceps 1x2 teeth cm. 15
- MF 64 - Micro forceps 1x2 teeth cm. 15
- MF 93 - Micro forceps str cm. 15
- MF 94 - Micro pinzetta cur cm. 15

Ophthalmic Microsurgery set

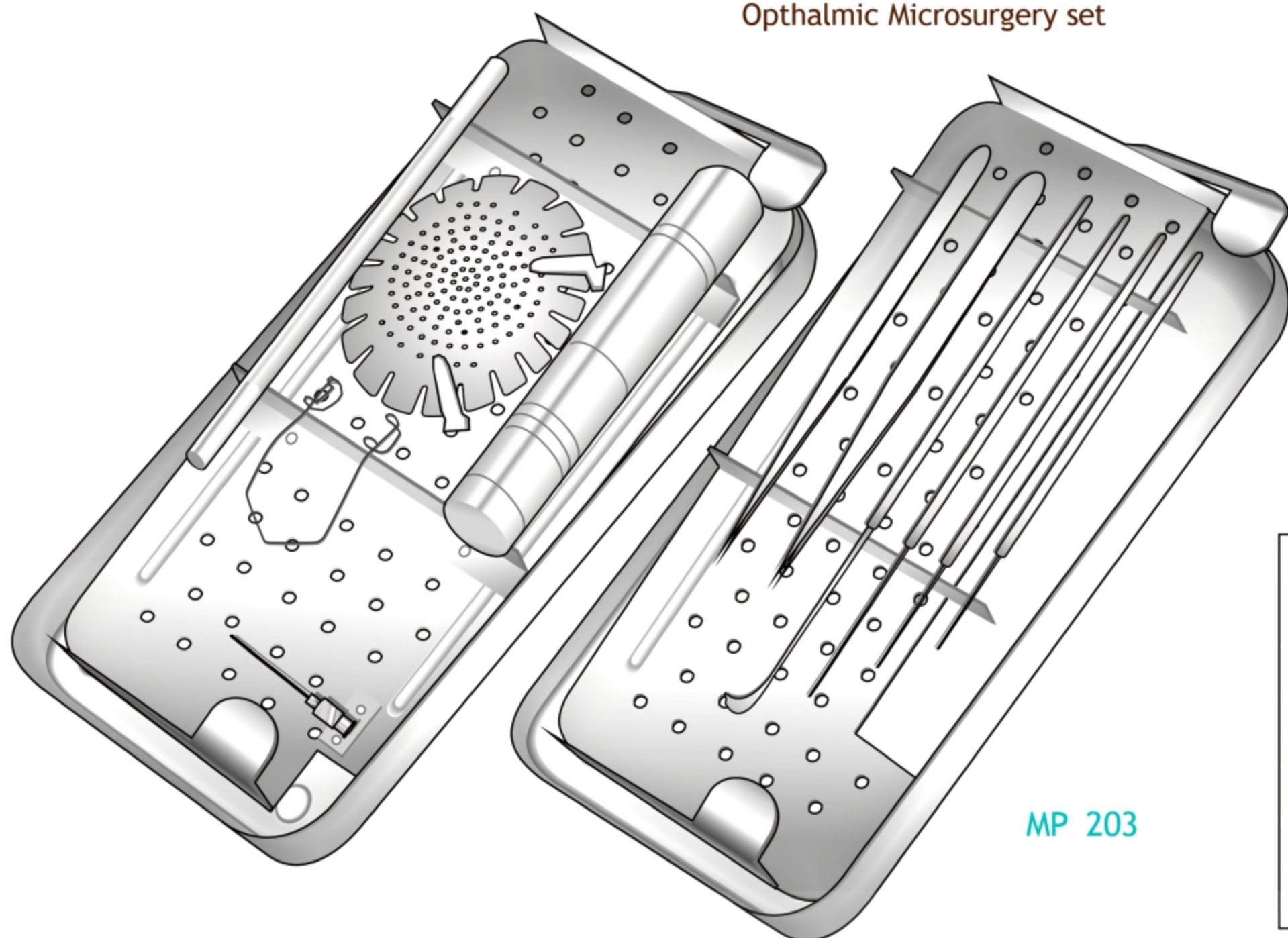

MP 203

**MP 203**  
Consisting

- BD 204 - Micro forceps cm. 12
- BT 70 - Div. Desmarres mm. 10
- MF 97 - Micro forceps cm. 8,5
- NK 09 - Scalpel Ellis cm. 12
- NK 48 - Spatula Kimura cm. 15
- NK 79 - Blefarostato Barraquer mm.27
- NK 97 - Dilator Wilder #1
- NK 398 - Pseudo ball lead
- OL 20 - Occluder aluminum mm. 75

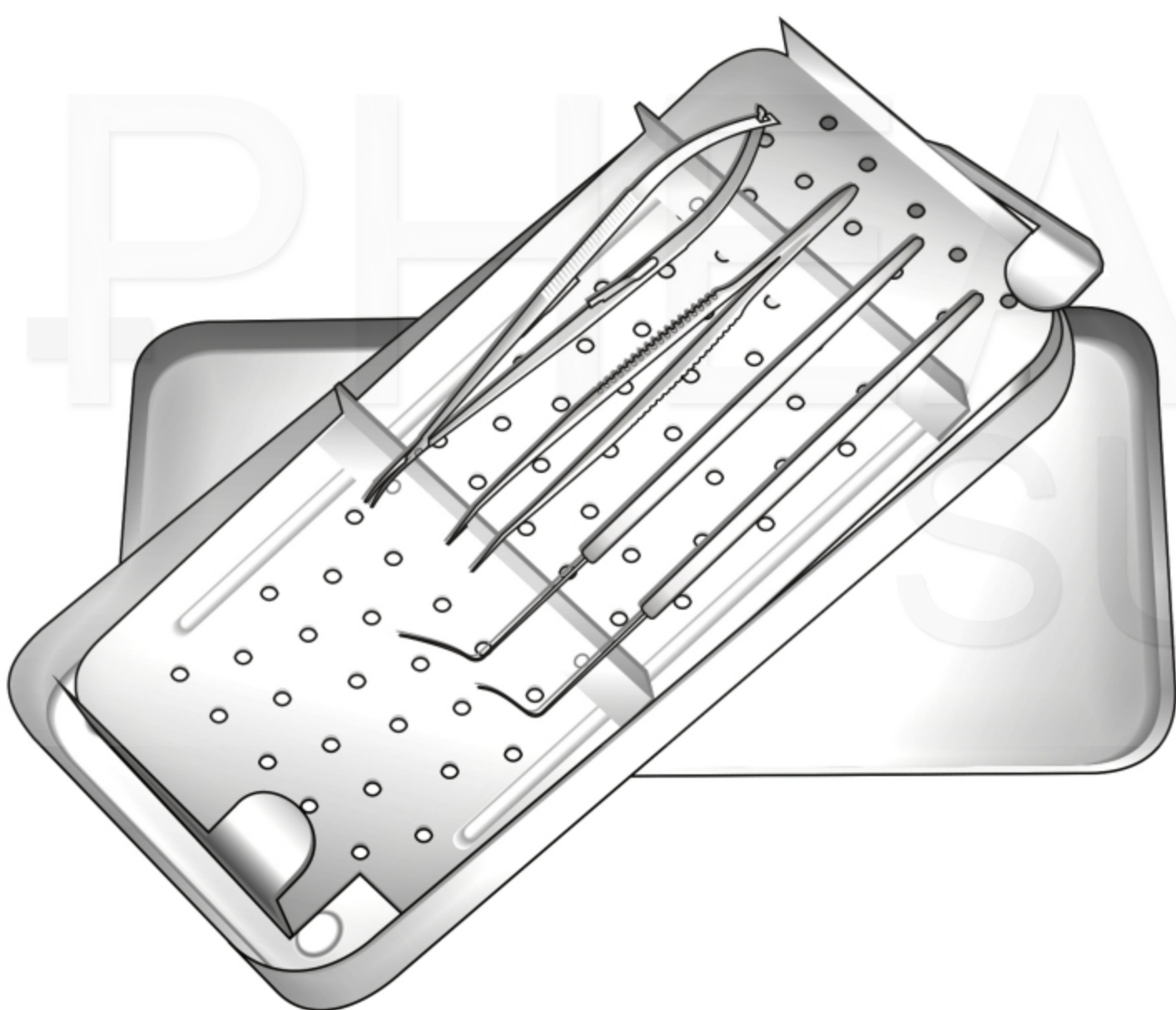

MP 204

**MP 204**  
Consisting

- BD 235 - Micro forceps cm. 12
- FD 132 - Micro forceps cm. 11
- NK 74 - Micro retractor mm. 0,2
- NK 75 - Hook angled cm. 13

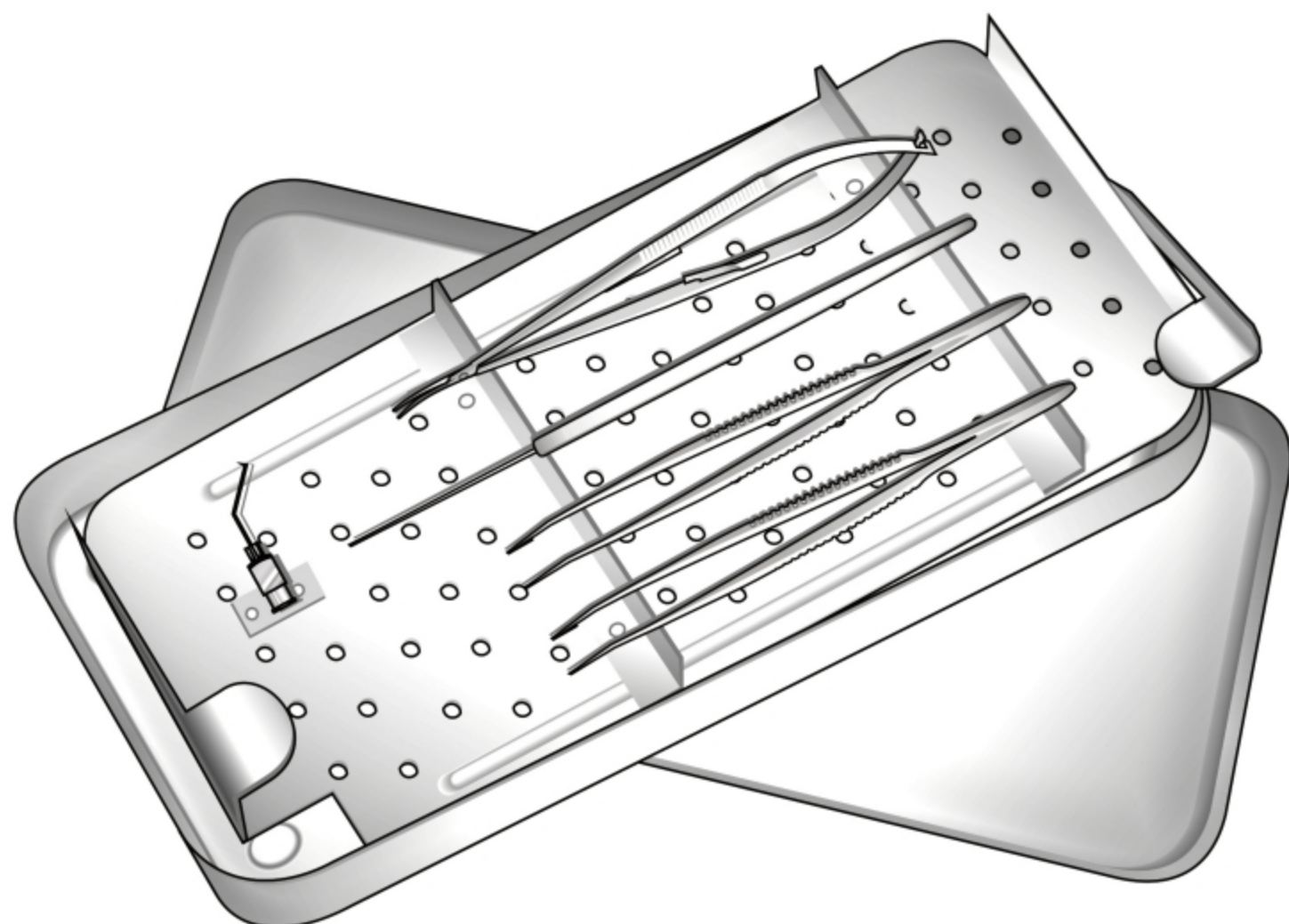

MP 206

**MP 206**  
Consisting

- FD 118 - Micro forceps 1x2 teeth cm. 9,5
- FD 123 - Micro forceps McPerson cm. 9,5
- FD 132 - Micro forceps crystalline cm. 11
- NK 93 - Micro spatula mm. 0,2
- OL 53 - Needle lacrimale curved mm. 35



Ophthalmic Microsurgery set

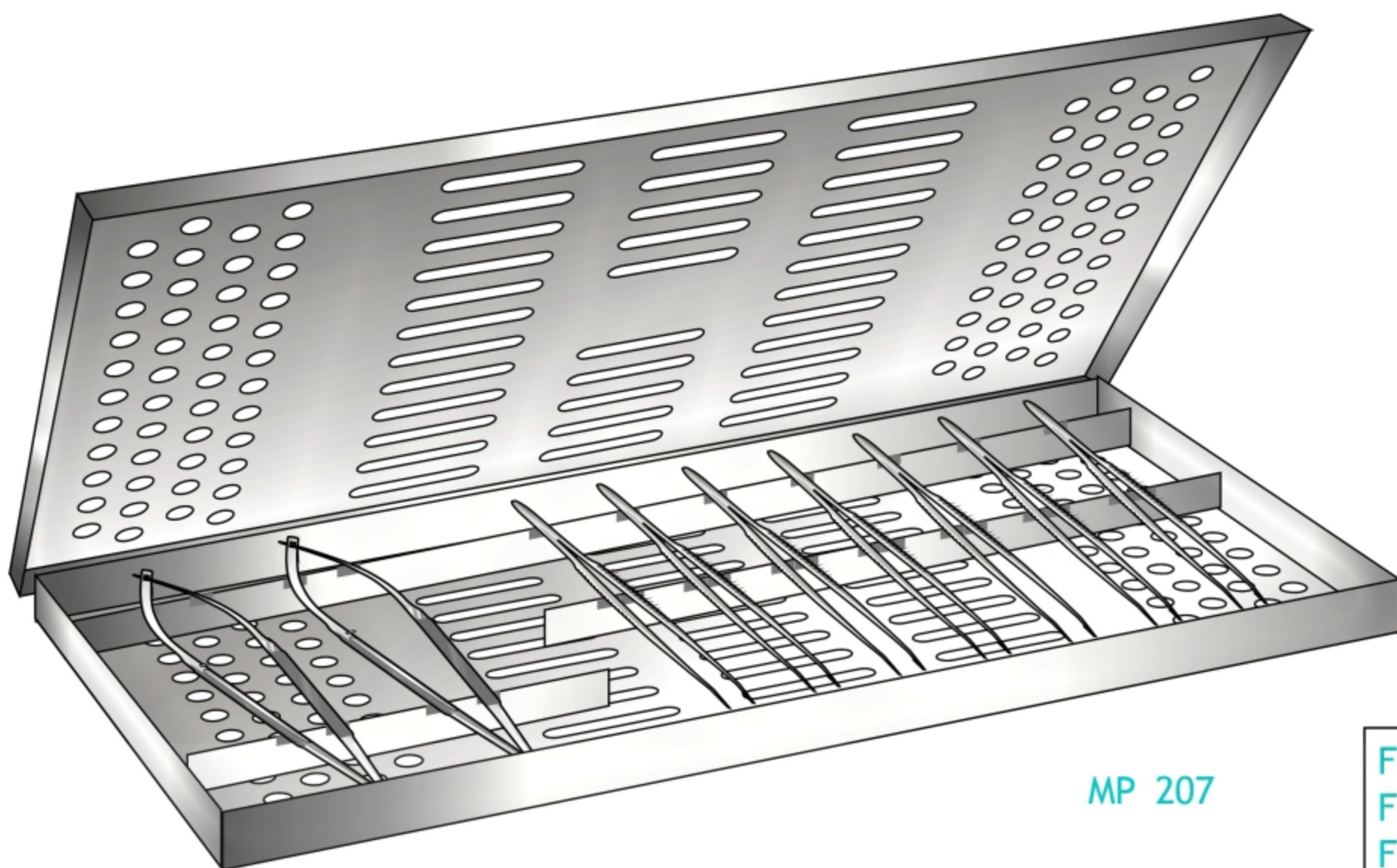

MP 207

MP 207  
Consisting

- FD 118 - Micro forceps 1x2 teeth cm. 9,5
- FD 123 - Micro forceps McPherson cm. 9,5
- FD 132 - Micro forceps crystalline cm. 11
- FD 136 - Micro forceps angled cm. 11
- MF 34 - Micro forceps 1x2 teeth cm. 9,5
- MF 40 - Micro forceps 1x2 teeth cm. 9,5
- MF 79 - Micro forceps straight cm. 9,5
- MF 80 - Micro forceps curved cm. 9,5
- NK 69 - Micro forceps Colibrì cm. 9,5

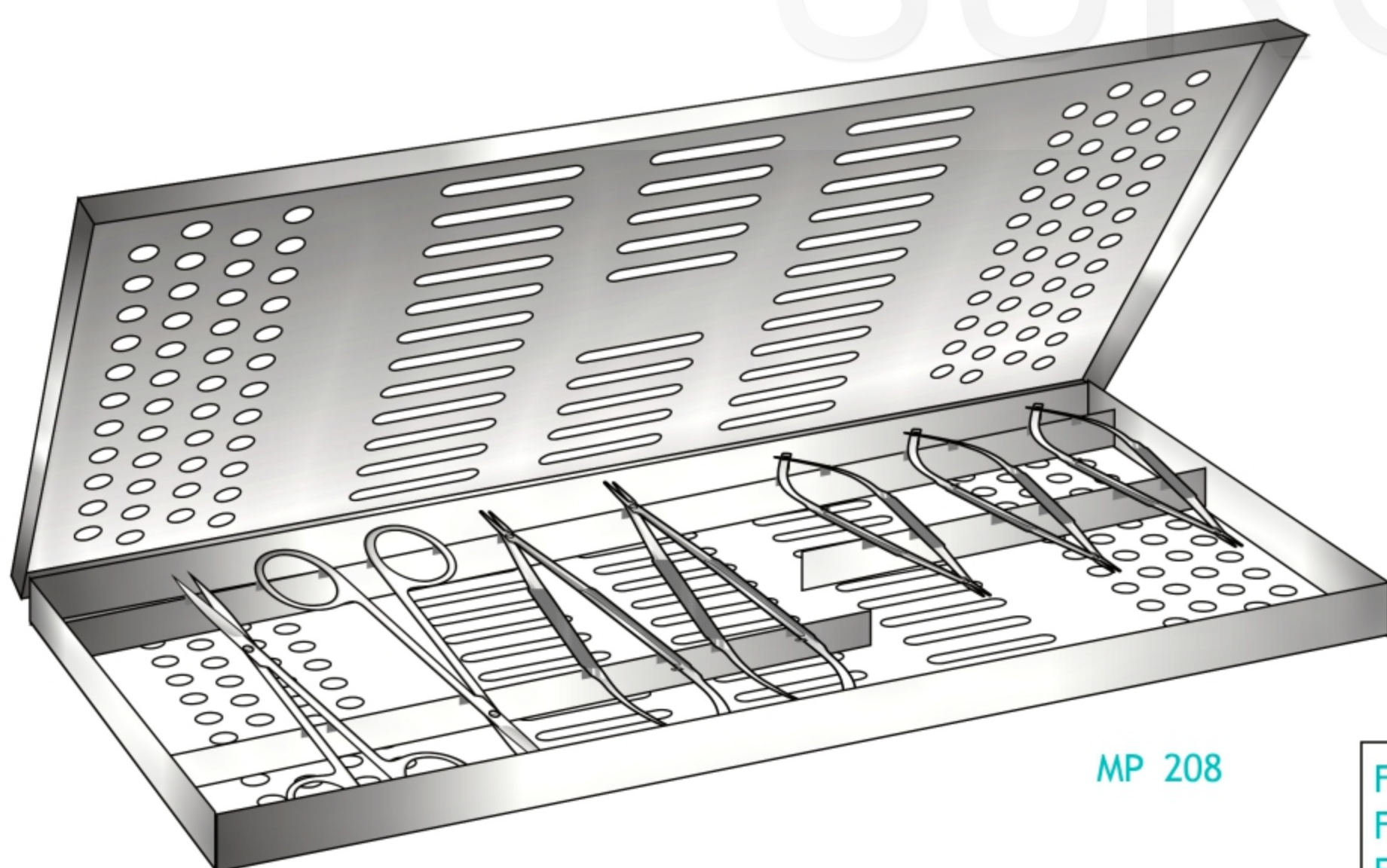

MP 208

MP 208  
Consisting

- FD 69 - Micro scissors Troutmann dx.cm.11
- FD 70 - Micro scissor Troutmann sx.cm.11
- FD 79 - .Micro scissor Vannas cm. 8,5
- FD 80 - Micro scissor Vannas cm. 8,5
- FD 81 - Micro scissor Vannas cm. 8,5
- FG 1 - Scissors Iris straight cm. 11
- FG 2 - Scissors Iris curved cm. 11

Ophthalmic Microsurgery set

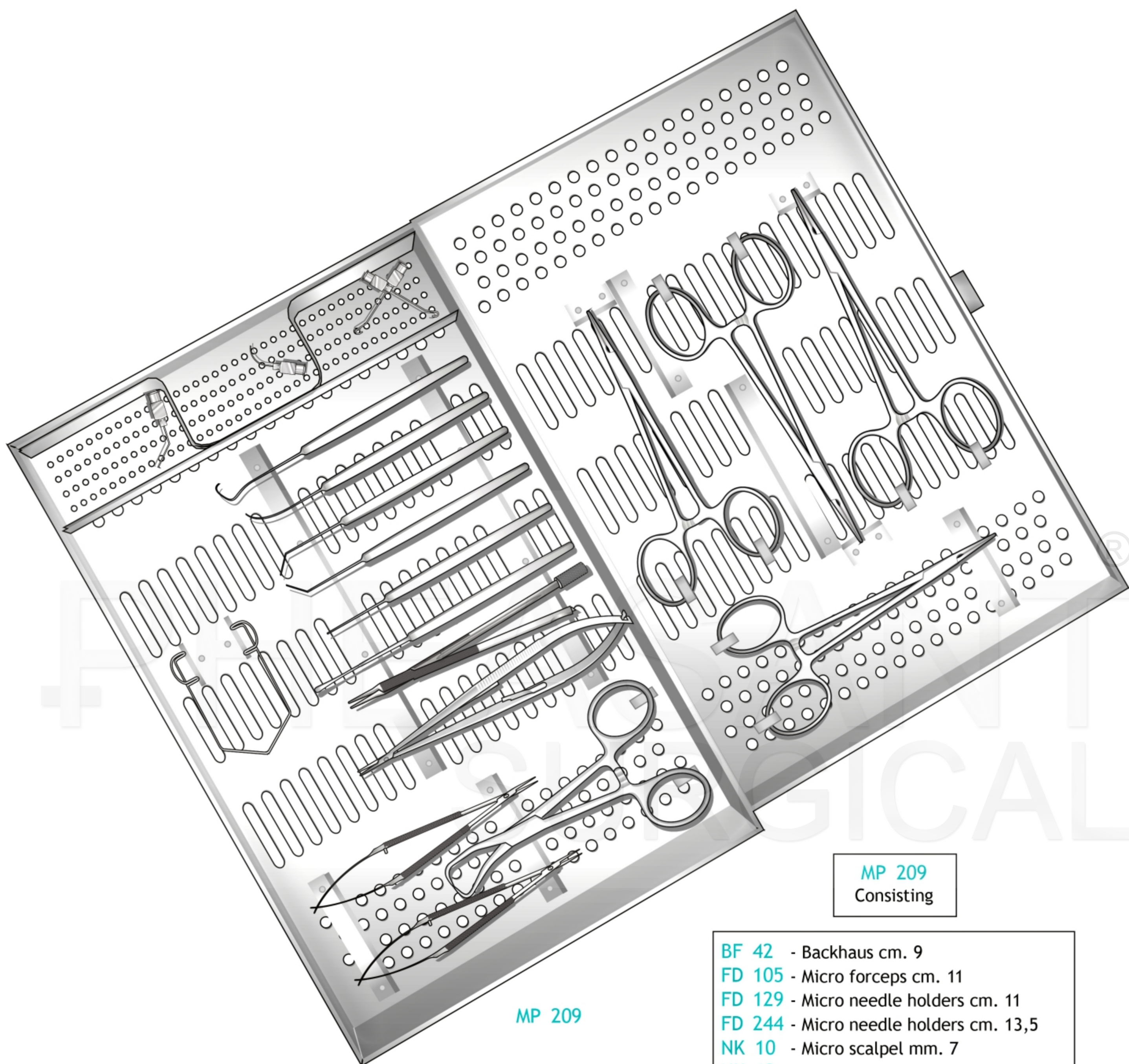

MP 209

**MP 209**  
Consisting

- BF 42 - Backhaus cm. 9
- FD 105 - Micro forceps cm. 11
- FD 129 - Micro needle holders cm. 11
- FD 244 - Micro needle holders cm. 13,5
- NK 10 - Micro scalpel mm. 7
- NK 12 - Micro Blade cm. 12
- NK 45 - Micro retractor Snellen cm. 12
- NK 59 - Arruga hook cm. 14
- NK 84 - Blefarostato Barraquer mm. 42x12
- NK 93 - Micro spatula mm. 0,2
- NK 110 - Micro spatula mm. 0,6
- NK 111 - Micro spatula mm. 1
- OL 51 - Needle lacrimal curved mm. 30
- OL 52 - Needle lacrimale 15° Sx.
- OL 53 - Needle lacrimale 15° Dx.
- OL 50 - Needle lacrimal curved mm. 35
- P 91 - Halstead straight cm. 12,5
- P 111 - Forceps Anat. Straight cm. 14